



# AIR UNIVERSITY **review**

NOVEMBER-DECEMBER 1973



**AIR POWER IN VIETNAM**





# AIR UNIVERSITY review

THE PROFESSIONAL JOURNAL OF THE UNITED STATES AIR FORCE

REFLECTIONS ON AIR POWER IN THE VIETNAM WAR . . . . .	2
Gen. George J. Eade, USAF	
SPACE PROPULSION: LET'S DO IT BETTER ELECTRICALLY . . . . .	10
Maj. Richard S. Baty, USAF	
THE EFFECTS OF IONOSPHERIC SCINTILLATION ON SATELLITE COMMUNICATIONS . . . . .	26
Allen L. Johnson	
PENS TO PIERCE THE MIGHTY AND DEGRADE THE SWORD . . . . .	32
Brig. Gen. Noel F. Parrish, USAF (Ret)	
SOVIET DISSENT: ITS SOURCES AND SIGNIFICANCE . . . . .	45
Maj. Ralph C. Gauer, USA	
Military Affairs Abroad	
PHASES OF SUBVERSION: THE CASTRO DRIVE ON LATIN AMERICA . . . . .	54
Jay Mallin	
Air Force Review	
THE CHANGING SCENE IN EDUCATION . . . . .	63
Maj. Charles W. Mitchell, USAF	
552d AIRBORNE EARLY WARNING AND CONTROL WING IN SOUTHEAST ASIA . . . . .	70
Lt. Col. Jerold R. Mack, USAF	
Capt. Richard M. Williams, USAF	
THE DEFINITION OF OPERATIONAL REQUIREMENTS FOR COMMUNICATIONS . . . . .	79
Maj. Chris N. Wilcox, USAF	
In My Opinion	
FAST BURNER: DOES HE HEAR A DIFFERENT DRUMMER? . . . . .	88
Lt. Col. Charles W. Roades, USAF	
WHY MILITARY AIRPLANES COST SO MUCH AND WHAT CAN BE DONE ABOUT IT . . . . .	94
Maj. Frederick T. Stark, USAF	
ACQUISITION AND IDENTIFICATION OF GROUND TARGETS . . . . .	102
Maj. Dan Eliason, USAF	
Books and Ideas	
SWORDS INTO BALLPOINTS: A NEW OUTLET FOR MILITARY EXPRESSION . . . . .	105
Col. Harley E. Barnhart, USAF	
WRITTEN PELLMELL? . . . . .	108
Col. Don Clelland, USAF	
THE CONTRIBUTORS . . . . .	110

Address manuscripts to Editor, Air University Review Division, Bldg. 1211, Maxwell AFB, AL 36112. Printed by Government Printing Office. Address subscriptions to Superintendent of Documents, GPO, Washington DC 20402, yearly \$9.00 domestic, \$10.00 foreign; single copy \$1.50.



the cover

In light of our experience in the air action in ETO during World War II, which led the U.S. Strategic Bombing Survey to conclude that "no nation can long survive the free exploitation of air weapons over its homeland," General George J. Eade reflects on the use of air power in Vietnam and draws a similar conclusion: limited application of force yielded indecisive results whereas appropriate application contributed to the achievement of the Allied objectives.





REFLECTIONS  
ON AIR POWER IN THE  
VIETNAM WAR

GENERAL GEORGE J. EADE





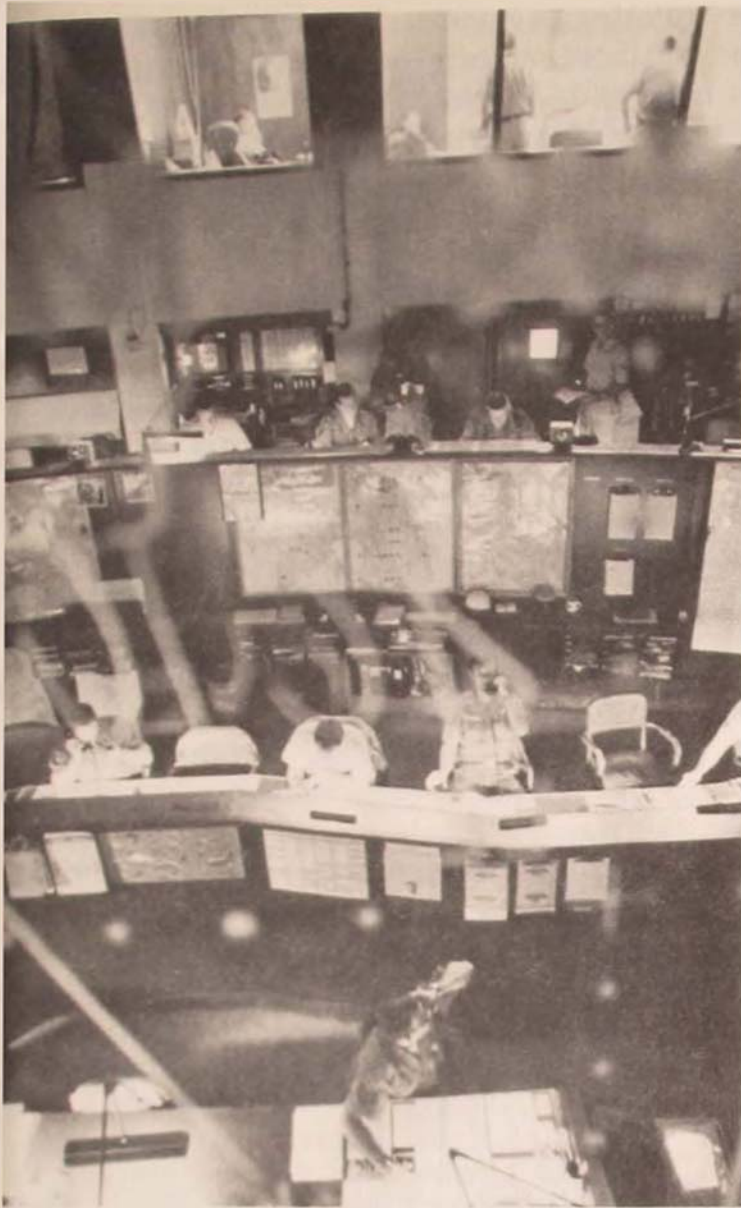

FOR an examination of U.S. objectives in Southeast Asia, the role of air power in achieving those objectives, and the reasons for success or lack of success in that achievement, an appropriate departure point might well be a brief examination of World War II and the international climate at that time. The overall objective of the Allied forces was rather simple and straightforward: the unconditional surrender of the Axis powers. To achieve this objective, air power was allowed to operate with little constraint and with the

full backing and support of our nation. The large-scale strategic bombing campaign against Germany and Japan proved to be a decisive factor in bringing the war to an end. In its most comprehensive conclusion on conventional strategic bombing that applies to the air war against both Japan and Germany, the World War II *United States Strategic Bombing Survey* states that "heavy, sustained and accurate attacks against carefully selected targets are required to produce decisive results when attacking an enemy's sustaining resources." It further concludes that "no nation can long survive the free exploitation of air weapons over its homeland."

The introduction of nuclear power at the close of World War II brought about the realization by policy-makers that the application of unrestrained military power could produce catastrophic results. The relatively unconstrained use of military power that prevailed during World War II was replaced by the tense atmosphere of the Cold War years, which led ultimately to the concept of limited war.

The limitation of war has been a key concern of U.S. Defense policy for many years. Much has been written on the dilemma of how to use military power to achieve a national objective in the face of an armed challenge without allowing the conflict to escalate in intensity through the spectrum of warfare. As the strategy of massive retaliation gave way to the doctrine of flexible response, the United States developed conventional capabilities for deterring or coping with

limited conflicts. These capabilities were intended to provide the decision-maker with options which would be credible in terms of the various levels of military confrontation. It is essential to recognize that to gain the initiative from an aggressor requires the national will and readiness to select options that make the aggressor's risk and cost incompatible with the objectives the aggressor hopes to achieve. One must, on the other hand, be forewarned that it is possible to select options which, in order to insure against drawing other nations into the conflict, offer a relatively lower probability of achieving military or political success.

Let us examine the Southeast Asia conflict. Some analyses of air power in the Vietnam conflict, particularly those done on the 1965-68 time period, have been critical of aerial bombardment as an instrument of national policy. These retrospective analyses, applying their own interpretations of the intended objectives of the bombing campaign, conclude that air power fell short of realizing these objectives.

Viewing these critical analyses, proponents of air power are much tempted to take issue with the conclusions and to offer pointed rebuttals in an effort to exonerate the principles and concepts of air power. To do so would, in essence, be engaging in the same sort of Monday morning quarterbacking that was employed by those analysts who have produced the stinging reviews of air power. It would seem more appropriate to consider objectively the bombing campaign during the 1965-68 time period, present the facts as we know them, compare results of that earlier period with the recent successful results of the 1972 air campaign, and arrive at conclusions based on our comparative analysis.

The administration in late 1964 and early 1965 faced an uncertain and per-

plexing decision in Vietnam. Concern over Chinese military reaction in the event of direct U.S. intervention was acute. There was a lack of public awareness in the United States of Hanoi's involvement in South Vietnam. The political situation in the South was unstable, and underlying the entire Indochina question was the unknown quantity of the Soviet commitment to North Vietnam (NVN).

Given the political and military environment of early 1965, the administration at that time chose closely controlled air attacks to signal U.S. intentions. The problem the administration faced was how to make such a signal clear and yet not risk unwanted escalation. There was inherent concern that the attacking of high-value targets in the North could carry the same risks as a full-scale campaign. The international political climate was against widening of the war. Rationale for the early decisions that limited the employment of air power in NVN appeared in a speech by President Lyndon B. Johnson on 7 April 1965 when he stated:

Our objective is the independence of South Vietnam and its freedom from attack. . . .

We have no desire to devastate that which the people of North Vietnam have built with toil and sacrifice. We will use our power with restraint and with all the wisdom that we can command.

The objectives of the air campaign launched in 1965 were defined by President Johnson:

-To back our fighting men and our fighting allies by demonstrating that the aggressor could not bring hostile arms and men to bear against South Vietnam from the security of a sanctuary.

-To exact a penalty against North Vietnam for her flagrant violations of the Geneva Accords of 1954 and 1962.

-To limit the flow, or substantially increase the cost, of infiltration of men and materiel from North Vietnam.



In my judgment the manner in which the air strikes were conducted did not signal strong intentions. Air operations in NVN were initiated under strict controls and specific guidance. The air campaign from 1965 to 1968 undulated with phases of gradual expansion and reduction. Our national leaders provided significant interludes in the bombing, to which it was hoped the enemy would respond by reducing the scope and level of the conflict; there were pauses for Vietnamese national holidays; long periods of poor weather reduced our air efforts and gave the enemy respite. Because of political constraints, the campaign operated under a set of firmly defined ground rules relating to target selection, areas to be bombed, level of effort, and tactics to be used.

Our limited application afforded the North Vietnamese some significant advantages. In 1965, NVN had made little preparation against air attacks: military targets such as petroleum, oil, and lubricant (POL) facilities and factories were not dispersed; her labor force was not mobilized for logistical repair and movement. The gradual application of air power allowed NVN to correct these deficiencies and denied us the capability of fully exploiting them. Additionally, the North Vietnamese and their allies demonstrated how rapidly a rudimentary air defense system can become significantly imposing.

The compounding effects of the political constraints and a strategy of graduated response resulted in the United States' launching an inconclusive, though expanded, bombing effort in hopes of persuading the enemy to capitulate.

Limited to relatively less lucrative, less meaningful targets, air power had the difficult task of carrying out an interdiction campaign against a target system consisting of jungle trails, mountain passes, and widely dispersed and, in relative terms,

inconsequential supply caches. Our forces were asked to do several things that they had not been designed or structured to do. These were to locate and track small targets in difficult terrain, and to attack them at night and in adverse weather with munitions that had been designed for other purposes.

It is appropriate at this point to refer to the objectives of the 1965-68 campaign as set forth by President Johnson. Those objectives were, by their nature, limited in scope, and the application of air power over the North was in consonance with the goals perceived by the administration. Unlike the full-scale employment of air power in World War II, the early bombing campaign had specific, limited objectives. As General Maxwell Taylor wrote, "The overall purpose was to apply limited force with limited means to gain limited results."

A review of the record reveals that air power was quite effective in achieving these limited objectives. Allied military forces and the people of South Vietnam *were* strengthened with the knowledge that air power was striking the enemy in his own territory. The North Vietnamese, with the conflict brought into their own homeland, had to devote critical resources to defense and repair. Moreover, the interdiction campaign *was* effective in limiting the flow of men and materiel to the South; greatly increasing the cost of NVN's aggression; and reducing the ability of the North Vietnamese to conduct offensive operations in the South. Weapons limitations and political constraints notwithstanding, there is good evidence that the bombing of critical chokepoints resulted in significant blockage of the NVN supply lines. Because of the role air power played in curtailing the southward flow of men and materiel and the reduction of stockpiles brought on through increased ground action by the allies, the North Vietnamese were forced



to withdraw several of their units from the ground battle. This withdrawal was interpreted as a gesture on the part of the North Vietnamese to reduce the level of conflict and played a part in the decision to halt the bombing in the fall of 1968. However, there was the belief in some quarters that perhaps we stopped the bombing at a time when Hanoi's steadfastness had begun to waver. History may well give credence to that belief.

WHILE not totally unrestrained, air power in the December 1972 campaign was given the opportunity to strike key targets, some of them of such significance as to be classified *strategic*. Not only were the political constraints less rigid, but we had also succeeded in the development and employment of some weapons with capabilities nonexistent during the 1965-68 time period. Electro-optically and laser-guided weapons added a new dimension in the art of aerial bombardment. The unprecedented accuracy of these weapons caused a severe crippling of the North Vietnamese logistic system and allowed air power to strike key industrial targets with little collateral damage. We have convincing evidence that the early results of the 1972 campaign were far more successful than our efforts during the 1965-68 period. Critical supplies and utilities such as POL and electrical power were reduced to a level that only the minimum essential functions of NVN government and defense could be maintained. Also the mining of Haiphong harbor by air power in the 1972 campaign reduced the resupply to NVN by sea to a trickle.

Throughout this long and unpopular war, the North Vietnamese had shown little willingness to negotiate a settlement, primarily because they were able to sustain their logistic networks and maintain constant pressure on the armies of South Vietnam, Laos,

and, in the latter stages, Cambodia. Their intransigence signaled long-held intentions of eroding the will of their enemies to resist and ultimately the taking over of all of Indochina. However, after the decision of the President in 1973 to resume the bombing of NVN (this time with determined intent and less restrained application of air power), coupled with intensified diplomatic overtures, the North Vietnamese backed away from their intransigence and entered into serious negotiations to conclude a peace settlement.

In actuality the 1972 campaign can be analyzed in two distinct phases. Phase I began with the resumption of full-scale bombing of North Vietnam following the Easter offensive in the South and lasted until mid-October when it appeared that peace was at hand. Phase II, in December 1972, lasted only eleven days, but those eleven days may well prove to be the most decisive period of the entire war; a period that, when the final accounting is taken, should provide unprecedented evidence of the capability of air power to achieve national objectives.

The difficult reality that the Hanoi leadership had to face was that its 1972 Easter offensive in the South had been a costly failure in terms of achieving even minimal military objectives. Moreover, the launching of the Easter offensive precipitated our decision to resume the bombing of the North, after which the North Vietnamese came to the conference table for serious negotiations. Patrick J. Honey, an eminent British authority on North Vietnamese affairs, in an interview with *U.S. News and World Report* (6 November 1972), was asked the question, "How important was the bombing of the North in pressuring Hanoi toward a negotiated settlement?" Mr. Honey answered:

The heavy bombing of North Vietnam was perhaps the vital factor which kept pressures on North Vietnam and maintained their in-

terest in continuing the negotiations with Dr. Kissinger. In 1968, on the advice of Clark Clifford [former Secretary of Defense], the bombing was stopped. This removed any sense of urgency on the Communist side. As a result, the negotiations got nowhere. But now the North Vietnamese leaders knew the bombing would continue. Therefore, they had an incentive to settle as soon as possible because the bombing hurt.

At the end of October 1972, the North Vietnamese indicated they wanted to talk, and we stopped bombing in the North. However, it soon became apparent that discussions had reached an impasse; not only were the North Vietnamese showing signs of assuming once again their posture of intransigence toward meaningful negotiations but there was clear evidence that they were again about to launch a major offensive.

A decision was reached by our policy-makers to resume bombing of the North, this time with the full might of all the U.S. air power resources in Indochina, including B-52 bombers. During an eleven-day period, B-52s flew more than 700 sorties against military and industrial targets in the Hanoi-Haiphong area in conjunction with about 1600 sorties by fighter-bombers. In an article in the *Washington Post* (24 January 1973), Joseph Alsop commented:

The targets chosen, it might be emphasized, were all war-connected, being military supply dumps, railroad switching and marshalling yards, electric power stations and so on. Judging by Hanoi's figure of under 1400 persons killed in the bombing, the B-52s clearly did a remarkably accurate job.

Pointing to the Hanoi casualty reports, the *London Economist* said the German Air Force "killed almost as many in a single night in what now seems to be the relatively mild bombing of Britain in 1940 and 1941." This intensive bombing campaign, flown against the most concentrated

air defense system in the world, signaled again to Hanoi the steadfast resolve of our commitment to South Vietnam and our willingness to employ air power to its maximum effectiveness in an effort to move the peace negotiations off dead center. It must be emphasized that it was the *total* air effort over the North that brought about the successful results: B-52s, tactical air fighter-bombers, electronic countermeasures and chaff aircraft, defense suppression aircraft, and MIG defenders working in a concerted effort to place weapons on targets. As Charles W. Corddry stated in the *Baltimore Sun* (24 January 1973):

The twin instruments of this strategy were the swift, systematic and sustained bombing campaign over North Vietnam with greatly intensified pressure in December, and the closing of its ports by naval mining.

Joseph Alsop summed up the December campaign this way:

. . . there is no question at all that the renewed bombing got the President what he was aiming for.

Even some of the political analysts who had earlier opposed the use of air power in the North began to change their minds. Commenting on the political significance of the recent bombing campaign, Stewart Alsop stated in *Newsweek Magazine* (29 January 1973):

According to Hanoi's figures, the B-52 bombing killed 1,318 people in Hanoi in twelve days. That is a lot of dead people. But the fact remains that the bombing was not mass bombing . . . If it had been, there would have been no more Hanoi.

I have written almost ad nauseam that the supposed omnipotence of air power is "the great American illusion." But I am beginning to wonder if the President was right and I was wrong. . . . It is surely at least possible that it [the B-52 bombing] too has led to important political results—a respectable



American extraction from a hated war, and perhaps even an end to the Communists' remorseless use of every form of violence, from tank-supported invasion to mass assassination, to impose their rule on South Vietnam. In that case, many more than 1,318 will be saved, which is why I begin to wonder if I was wrong.

A postoperation summary of the eleven-day bombing campaign provides irrefutable evidence on the nature of the targets struck and the crippling effect that air power had on North Vietnam's war-making potential. Bombing the rail system alone resulted in an almost total suspension of rail traffic in the Hanoi-Haiphong area. In the past when North Vietnamese rail installations had been struck, repair crews were at work immediately building bypasses to the damaged areas. During the eleven-day campaign, the rail system was struck with such intensity and regularity that, as postmission photography reveals, repair crews made no attempt to restore even token rail traffic. Concurrent with raids on the rail system, B-52s and fighter-bombers struck major supply depots where the North Vietnamese stored war materiel prior to shipment to the South. Resultant damage, confirmed by photography, was the virtual destruction of several hundred warehouses and storage buildings. Raids on North Vietnam's three major power plants reduced the country's electrical power output from 92,000 kilowatts to between 17,000 and 24,000 kilowatts, causing a complete blackout of all but the critical functions of government and defense that required electrical power. Militarily, the December bombing campaign achieved the intended objective of seriously degrading the enemy's capability to wage war in the South. Far more significant, however, is the fact that our nation's political objectives were supported by the rapid, concentrated application of air power in an effort to bring about a cease-fire and

the ultimate end of the war for the United States in Southeast Asia.

THERE are several conclusions that can be drawn from this examination of the role of air power throughout the Indochina War. First, there is the realization that air power along with other U.S. and allied forces had been engaged since 1965 in one of the longest wars in U.S. history. Militarily, a long war is disadvantageous. If we possess a capability to apply force rapidly and massively (massively in relation to the opposition, not in absolute terms), presumably we can end a war quickly. With such an alternative available, if we allow the war to continue over an extended period it is because of a decision to impose restrictions on the forces we employ—a decision prompted by a desire to limit the scope of the conflict.

Nevertheless, from the purely military point of view, such restrictions produce numerous disadvantages. The enemy is given time to study, adjust to, and counteract our strategy, tactics, and weapons. He is given time to deploy new weapon systems or to perfect and expand existing ones (witness the formidable North Vietnamese air defenses built up during the earlier bombing campaign); to create different routes of supply (the jungle highways through Laos and sea-fed routes through Cambodia); to train large numbers of people to be effective troops; to redistribute his population; to disperse his vital industries; to duplicate and build bypasses to critical communications links; to develop and employ successful propaganda themes. In short, we may surrender or seriously compromise the initiative and so make the war much more expensive and difficult to win.

Second, when the political climate requires the imposition of constraints on military forces, serious consideration must



be given to existing limitations in force capabilities. This is not to say that military forces can achieve an objective only when unconstrained and given a free rein; but, rather, a balance must be reached in the decision-making process between political constraints and force limitations so that the ability to achieve a desired objective is optimized. It is in this area that the "can-do" spirit of the military sometimes works at cross-purposes to the accomplishment of an assigned task. The overriding tradition in the military is to salute smartly and move out even when faced with limited capabilities. Just as military leaders must face the reality of political constraints, so is it important that a nation's policy-makers understand that extensive political constraints in concert with force limitations may produce an outcome that falls short of anticipated objectives.

Finally, as the limitations in force capabilities are reduced by advancing technology and the changing face of the war brings

about a lessening of political constraints, the appropriate application of military power can indeed contribute significantly to the achievement of desired objectives. I believe that the experience of the eleven-day campaign in December 1972 should provide convincing lessons in the future employment of air power as an effective instrument to be used in support of national policy. Perhaps these valuable lessons will allow us to update the findings of the World War II *Strategic Bombing Survey*, to show that "no nation can long endure the swift, accurate, concentrated application of air power and still hope to achieve any measure of victory."

The ultimate objective in Southeast Asia has been identified as a just and honorable peace. Air power, alone, cannot take full credit for bringing the war to an end; but the establishment of serious peace negotiations and the long-awaited cease-fire agreement that followed were in large part due to the application of air power.

*Hq United States European Command*

CHEMICAL propulsion systems will continue to be the mainstay of space propulsion for the foreseeable future. Many gains still remain to be realized in this area. Such items as improved packaging, reusability, reduced costs, and increased durability are major goals of the current Air Force rocket propulsion technology program. This program is structured so as to make potential improvements a reality within the next five to ten years. Beyond these improvements, it is necessary to look to other than chemical propellants to increase propulsion performance substantially. This is where electric propulsion systems offer promise. These systems, through vastly improved propellant mass utilization, have the potential to serve us better electrically. At the present time, electric propulsion devices for Air Force space applications are being developed for utilization at low thrust levels. This situation is dictated by the fact that the present shortage of available electrical power aboard spacecraft would prohibit large thrust levels from being attained by electric propulsion systems. Even so, there are a number of space propulsion functions for which electric propulsion systems

## SPACE PROPULSION

*Let's Do It Better Electrically*

MAJOR RICHARD S. BATY

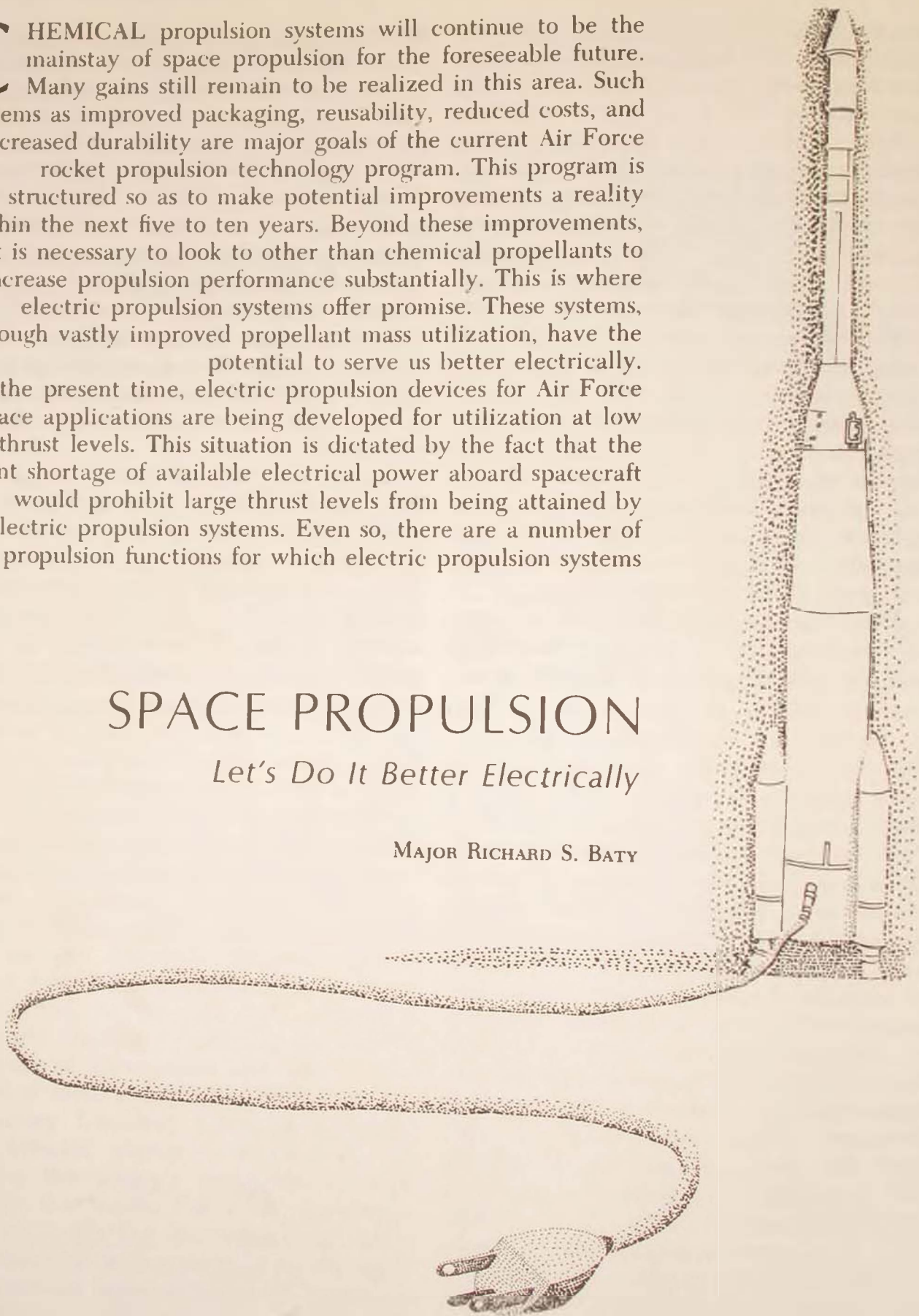

are becoming prime contenders. Such functions as satellite attitude control and orbital maintenance appear ideal for certain electric propulsion devices. The attractiveness of these devices stems from their ability to utilize propellant mass so efficiently at the necessary thrust levels. For example, a certain satellite propulsion function could be performed using far less propellant through employment of electric propulsion. The savings in propellant consumption could be realized through launch weight savings, increased payload, longer satellite missions, or a combination. These alternatives could potentially reap considerable benefit in terms of launch costs, material utilization, and mission coverage.

But where should electric propulsion ultimately lead us? The answer to this question is that a patient development effort could enable us to perform spatial propulsion maneuvers that are not attempted today. The ability to perform these new maneuvers will be highly dependent upon harnessing more efficiently the vast amounts of energy that are available in the universe. At the present time our energy pioneers such as Hannes Alfvén<sup>1</sup> are pointing to new sources of untapped energy, solar winds, for instance. These sources could enable us to reduce space repositioning and travel times significantly through employment of specific electric propulsion devices. As we reach these new acceleration regimes, other ways of improving acceleration mechanisms will probably be identified. The main point to remember is that we must retain our pioneer spirit. Indications are that we have a long path ahead of us in the area of propulsion refinement.

This article briefly describes the electrical acceleration processes from the basic electrostatic and electromagnetic aspects through the fascinating theory of magnetic-field annihilation. The role of electric propulsion is then assessed in light of postulated military missions. Finally, future propulsion

regimes for electrical thrusting systems are hypothesized.

In any discussion of rocket propulsion, two parameters are of extreme importance: total impulse and specific impulse. Total impulse establishes the magnitude of the thrust and the duration of the thrusting time that are necessary to complete a certain mission. For example, in an orbit-changing mission, to transfer from one orbit to another, changes in velocity must be imparted to a satellite. These changes can be accomplished by using rocket engines to provide thrust for a certain time period. Thus, the engines provide the correct total impulse for entering the new orbit.

A very important question now arises: How much fuel will be required to provide the specified amount of total impulse? To achieve thrust, particles of propellant are expelled at a certain velocity. A desired thrust level can be achieved by either expelling more particles at a lower velocity or fewer particles at higher velocities. Naturally, it is more desirable to accelerate particles to as high a velocity as practical, since fewer particles in the acceleration process will result in less propellant weight. In fact, some desirable military space missions, such as sizable repositioning maneuvers, would require optimum propellant utilization in space in order to maintain allowable spacecraft launch weights. Furthermore, launch weights have now been transcribed into dollars per pound.<sup>2</sup> For these reasons, it behooves us to use each propellant particle in space in as efficient a manner as possible.

We are now ready to define specific impulse, since it is a measure of how efficiently each propellant particle is used. Specific impulse is generally defined as the velocity imparted to the propellant divided by gravitational acceleration. In meter-kilogram-second (MKS) units, the velocity is greater than the specific impulse by a factor of ten. Thus, by knowing the specific



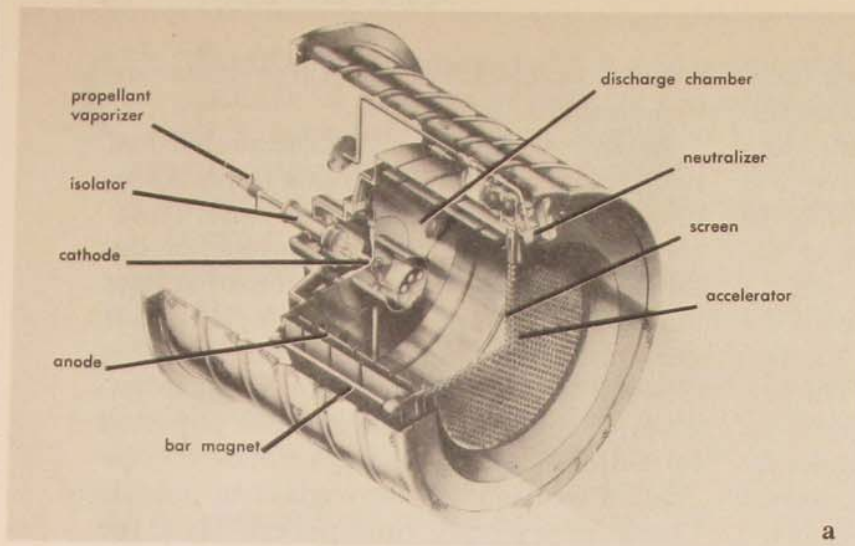

## SERT II

The second test in the Space Electric Rocket Test (SERT) program, managed by NASA's Lewis Research Center, Cleveland, was begun in 1970 to evaluate thrust over an extended time period. Mercury propellant is fed into the electron-bombardment thruster (a), heated to a vapor, and bombarded by electrons in the discharge chamber. Electrons split off the propellant atoms to form ions, which are attracted to the electric field between the screen and accelerator at back of engine. Ion velocity of about 50,000 mph, emitted through holes in the accelerator grid, produces

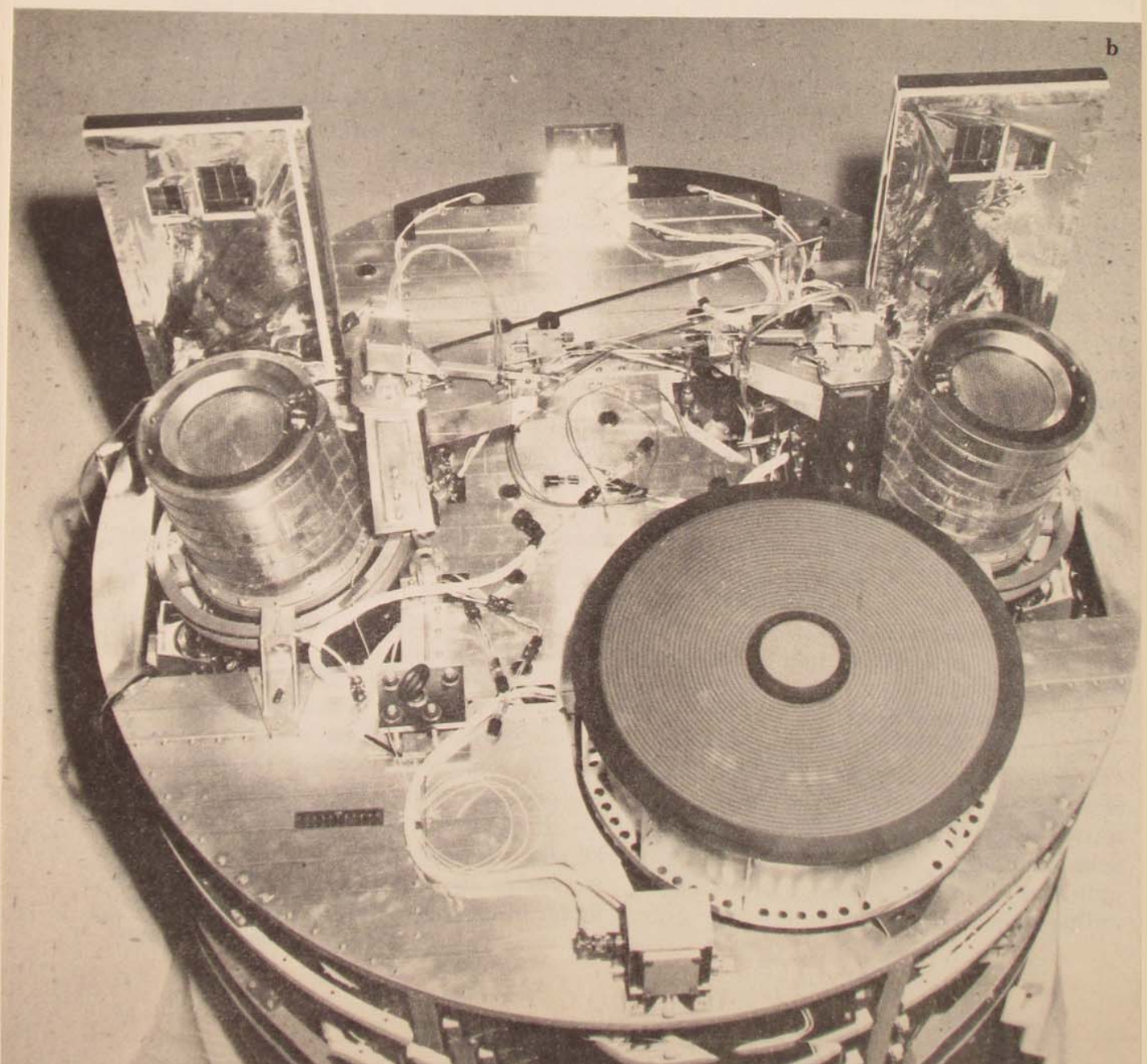



thrust—6 millipounds (.006) in the 15cm-diameter SERT II engine. . . . Two ion engines (b) propel SERT II to orbit 621 statute miles high. . . . Artist's concept of SERT II in orbit (c). The spacecraft carrying two electric thrusters and related experiments is attached to Agena second stage; a 1½ m solar cell array is attached at the other end. . . . SERT II as presented to Aerospace Industry contractors on 6 February 1970 (d) . . . Final ground testing of SERT II before launch on its mission (e): to evaluate the ion engine in space for an extended period of time, to measure contamination of solar cells or degradation of optical surfaces in space, to record radio frequency interference from the thrusters, and to determine the spacecraft's potential relative to space and the ion beam.

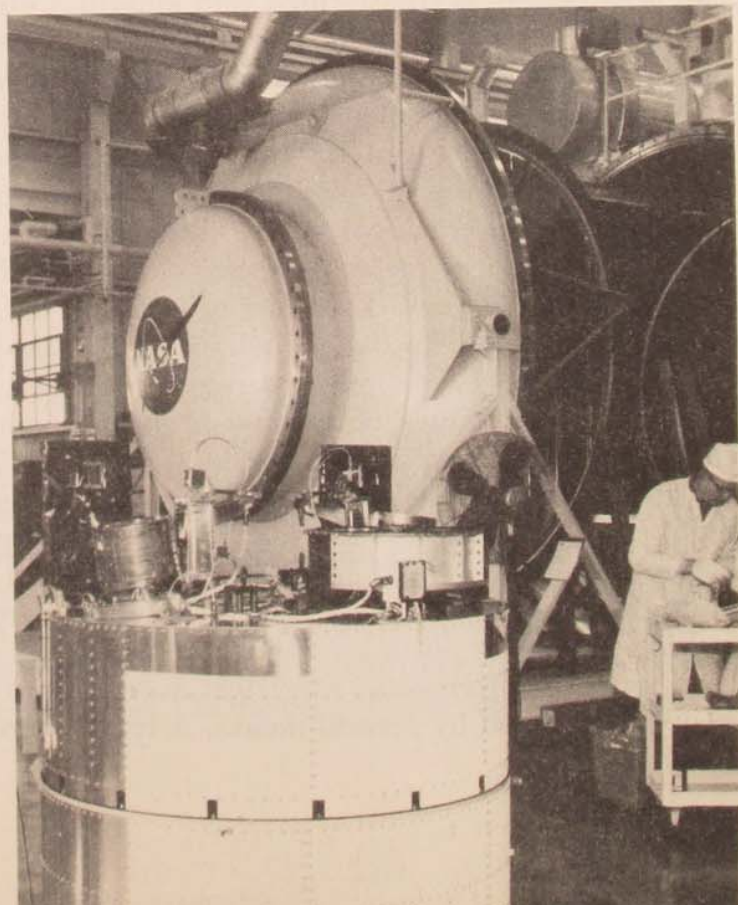
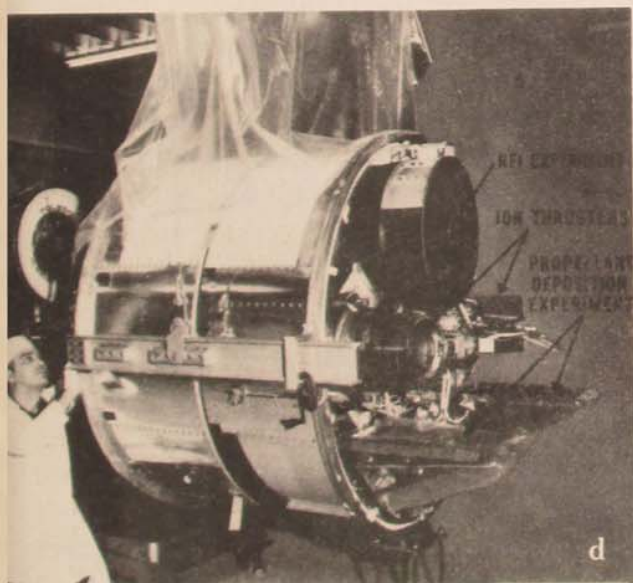
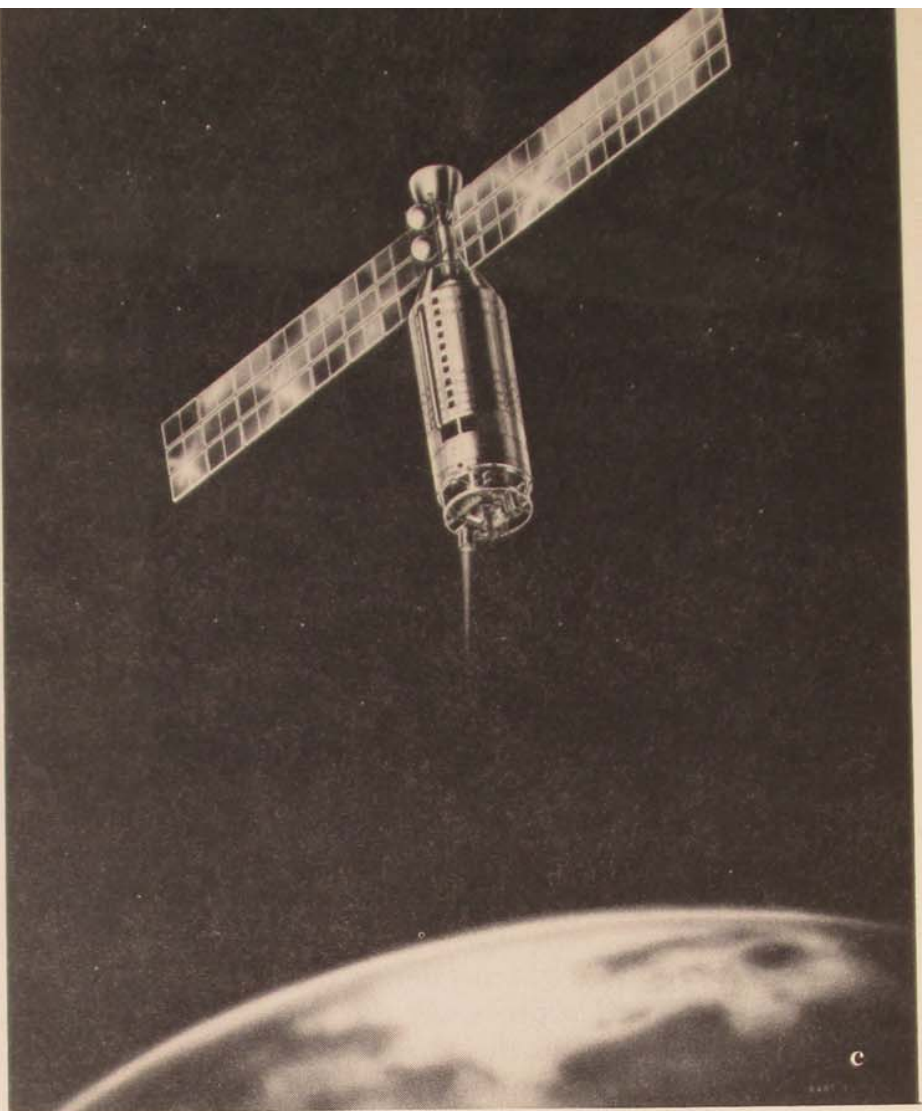

impulse capability of a system, we know how efficiently the system is using its propellant. Specific impulse has the units of seconds in the mks system.

The practical implication of specific impulse can immediately be seen by considering the amount of propellant needed to provide a certain total impulse. The propellant weight is determined by dividing the total impulse by the specific impulse. Thus, if a system were operating at a specific impulse of 300 seconds, 200 pounds of propellant would be required to provide a total impulse of 60,000 pound-seconds. If the specific impulse were somehow doubled, then the corresponding propellant weight would be halved.

#### Facets of Chemical and Electric Propulsion

Chemical propulsion systems derive their energy from internal sources. As the propellant ignites, energy in the form of heat is given off in great quantities. By expanding the propellant exhaust through a nozzle, heat energy is transformed into kinetic energy of the exhaust products. There is an upper limit to the amount of internal energy available in chemicals. It appears that chemical propulsion systems cannot exceed a specific impulse of 600 seconds.<sup>3</sup>

In contrast to chemical systems, electric propulsion devices receive their energy from external sources. This energy is used to furnish a "push" to the propellant particles. Electric systems are therefore not limited to low values of specific impulse. In fact, electric propulsion devices have routinely operated at specific impulses as high as 5000 seconds. Provided that the external energy is available, the attainment of high specific impulses by electric propulsion devices is not a problem.

In space environments, electrical energy may be furnished by several means. A typi-

cal example of today's spatial energy source is the solar array. The Air Force Aero Propulsion Laboratory is currently examining such arrays to generate 10 to 20 kilowatts of power. At this power level, enough energy can be furnished to an electric thrusting device to furnish fractions of pounds of thrust at specific impulses in the range of 1500 to 3000 seconds. Granted, not all satellites will have this much power aboard, and not all the available power will be continually at the disposal of the electric thruster. However, suggested power allocations<sup>4</sup> indicate that sufficient power is available for electric thrusters to negate forces which cause orbital perturbations and to perform repositioning functions in which time constraints are minimal. The vast propellant weight savings that could conceivably be derived through employment of electric propulsion could then be used advantageously in many ways.

Looking ahead to the 1980s, we anticipate the availability of nuclear power supplies for space applications. Additionally, solar array technology is expected to increase rapidly over the coming years. Power levels of up to 75 kilowatts have already been predicted for solar arrays.<sup>5</sup> Probably equally important, new sources of untapped energy such as solar winds<sup>6</sup> are now under close scrutiny. All these facets add up to the fact that electric thrusters could produce substantial thrust levels as well as high specific impulse. The realization of such thrust levels would allow electric propulsion devices to perform repositioning functions in which time constraints were significant.

Thus chemical propulsion systems, while capable of attaining high thrust levels by expelling large amounts of propellant at relatively low velocities, necessitate very large vehicles to contain the required amount of propellant. On the other hand, electric propulsion devices use their propellant much more efficiently but require external energy



sources. The further evolution of electric propulsion devices, then, will be heavily dependent on the evolution of energy sources.

### Electric Propulsion Devices

High-specific-impulse electric thrusting devices are of two types, electrostatic and

craft, a neutralizing device is utilized. This device produces negative particles, which join the propellant stream. The result is that the mass leaving the spacecraft is neutral and will not have further attractive interactions with the spacecraft.

In contrast to the electrostatic device, an electromagnetic device works in the following manner. An electrical current is estab-

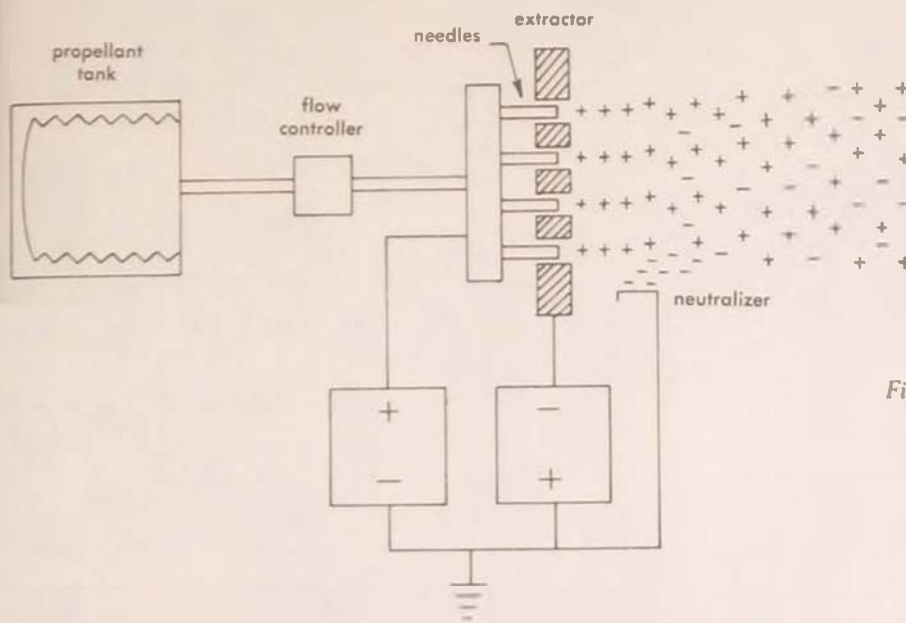
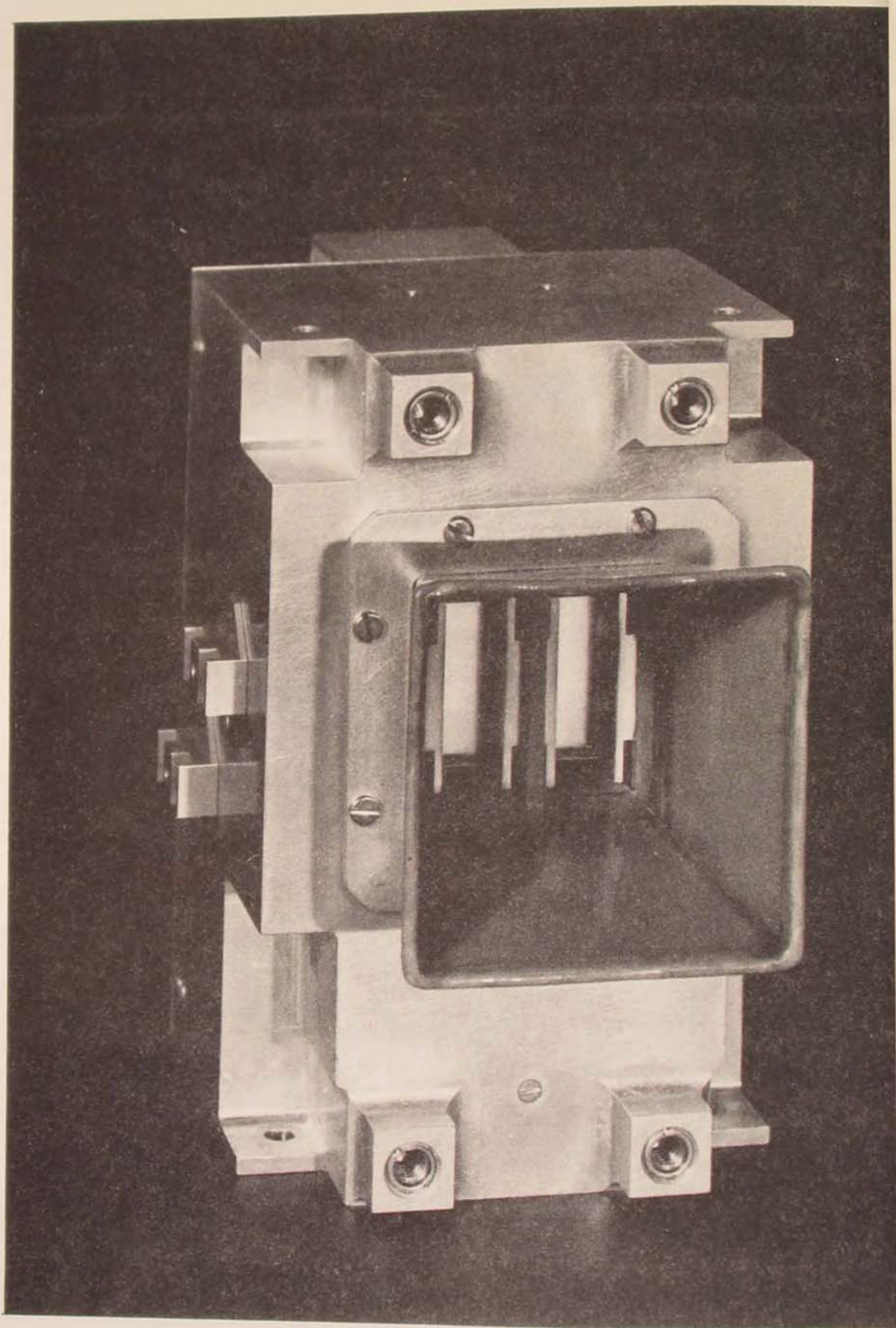

Figure 1. Colloid thruster unit

electromagnetic. Electrostatic devices operate by accelerating charged particles through a difference in electric potential. Figure 1 depicts the acceleration process occurring in electrostatic thrusters. The propellant is first ionized by such means as application of electric forces or induction of chemical reactions. Once ionized, the propellant carries a positive charge. Particles of charged propellant are accelerated by means of a plate that is at negative potential. The propellant proceeds outward through symmetrical openings in the plate. To prevent the propellant from circling around and reattaching to the space-

craft, a neutralizing device is utilized. This device produces negative particles, which join the propellant stream. The result is that the mass leaving the spacecraft is neutral and will not have further attractive interactions with the spacecraft. In contrast to the electrostatic device, an electromagnetic device works in the following manner. An electrical current is estab-

lished in a conductive propellant, which is in the presence of a magnetic field. The magnetic field interacts with the current to generate a force on the propellant. This action is identical to the process occurring in an electric motor. In a motor, a conductor is placed on a rotor. The rotor, being in a magnetic field, spins when current is driven through the conductor. There are presently reasons to research both electrostatic and electromagnetic systems. Electrostatic systems are higher in efficiency, which means they need a lower amount of input power to perform a certain mission. On the other hand, electromagnetic



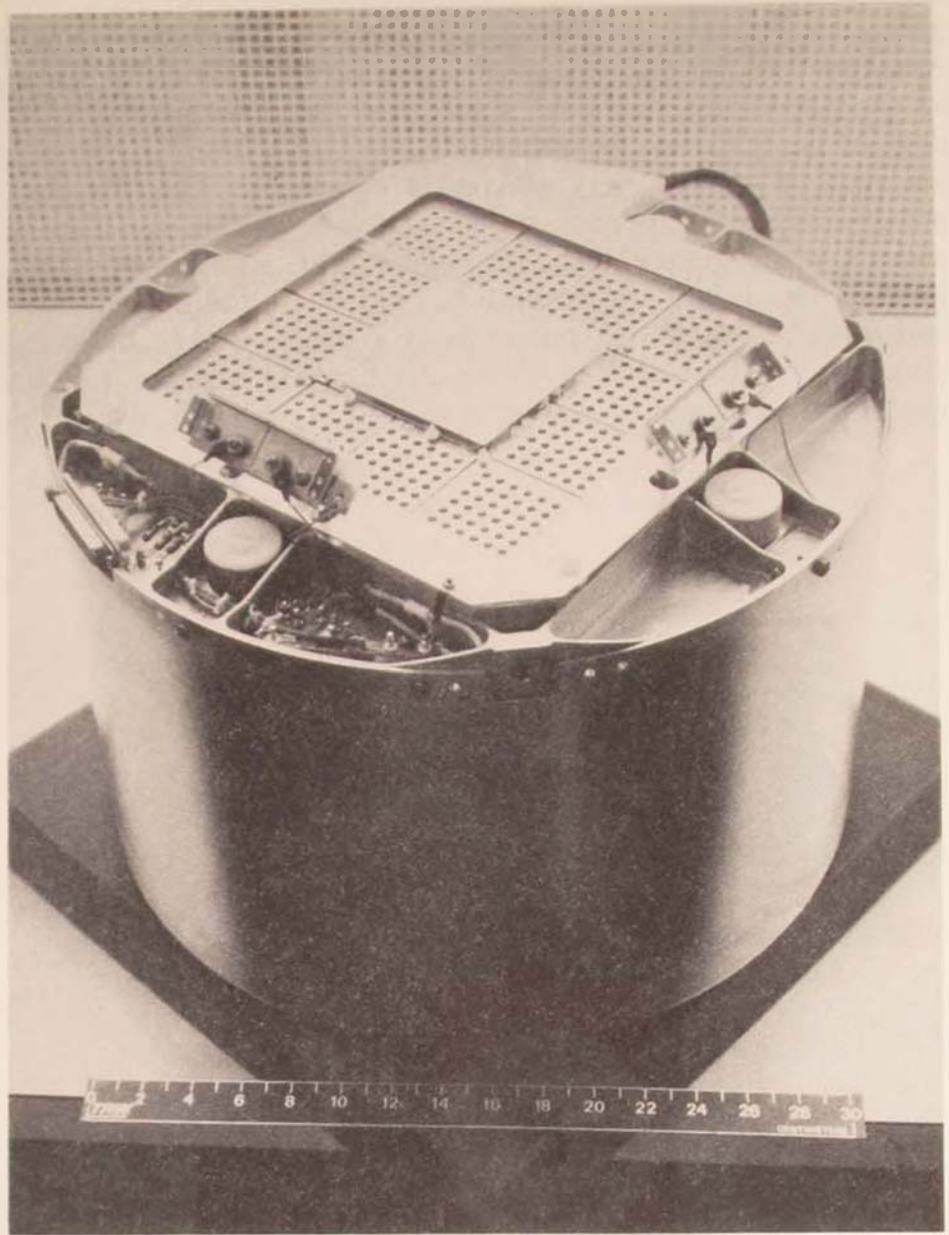

*The pulsed plasma thruster (left) was used successfully on the Lincoln Laboratory spacecraft LES-6. . . . The Advanced Development Program for the colloid thruster (right) is an electrostatic device, which, by a difference in electric potential, accelerates charged particles.*

thrusters are marked by simplicity of operation and high energy density. The feature of high energy density allows electromagnetic thrusters to provide high thrust levels with frontal areas of much smaller size than a corresponding electrostatic thruster. Additional attractiveness of electromagnetic systems is that, by virtue of their pulsing feature, they apply equally well to spinning spacecraft and three-axis stabilized space-

craft. Thus, if a spacecraft is spinning for stability purposes, the electromagnetic thruster can be pulsed at a time that will produce thrust in the desired direction. In contrast, most electrostatic systems operate continuously over fixed periods.

Two electrostatic concepts are presently under development by government agencies: NASA is developing ion engines, and USAF is developing colloid engines. The main



difference between the ion and the colloid concepts lies in the charge-to-mass ratio of the propellant particles. Each of these devices has its own operating regime. The ion systems operate very efficiently at approximately 3000 seconds specific impulse and up, while the colloid is very efficient at specific impulses of approximately 1500 seconds and below. When power is at a premium, as it will be aboard certain Air Force spacecraft, the colloid engine is indeed at-

static systems, pulsed plasma systems are relatively insensitive to parameters such as temperature. Thus they are free of complex control system loops.

The Air Force is presently developing two specific pulsed plasma devices: the solid-propellant pulsed plasma thruster and the pulsed inductive thruster. The rationale is that the solid-propellant (Teflon) device appears to be optimum at lower thrust levels while the pulsed inductive thruster

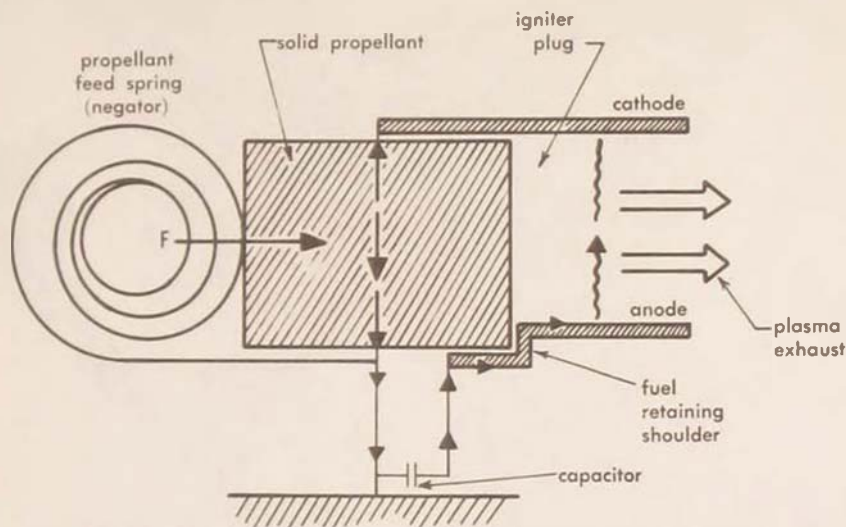

Figure 2. Pulsed plasma thruster

active because the tight limitations on output power prohibit operating at the extremely high specific impulses.

The Air Force and NASA, in a closely coordinated effort, are also presently working on the development of electromagnetic devices. These devices, known as pulsed plasma thrusters, look very attractive for many space applications, a big plus being the simplicity of their operating concept. Essentially, all that is necessary is to discharge a capacitor bank through a selected coil. The propellant is then electromagnetically accelerated. Unlike the electro-

static systems, pulsed plasma systems are relatively insensitive to parameters such as temperature. Thus they are free of complex control system loops. The Air Force is presently developing two specific pulsed plasma devices: the solid-propellant pulsed plasma thruster and the pulsed inductive thruster. The rationale is that the solid-propellant (Teflon) device appears to be optimum at lower thrust levels while the pulsed inductive thruster appears better at higher thrust levels. As indicated earlier, the electrostatic systems are eliminated at higher thrust levels due to their low energy density. However, the Teflon thruster is being considered at thrust ranges that are in direct competition with the electrostatic devices. The issue at hand is the simplicity and pulsing feature of the solid-propellant thruster versus the lower power requirements of the electrostatic systems. At present, the involved trade-offs make both systems worthwhile to pursue.

The solid-propellant pulsed plasma thruster operates by discharging a capacitor bank

across a pair of electrodes. (Figure 2) The energy developed across the electrodes ablates and accelerates the solid propellant. This thrusting concept has already operated reliably in space aboard the Lincoln Laboratory spacecraft LES-6. The function of the solid-propellant thruster aboard LES-6 was to produce micropounds of thrust to counteract forces on the spacecraft caused by the earth's oblateness. Presently, Air Force efforts are directed at evolving this

current and magnetic field energy generates forces by which the propellant is accelerated. This concept is more complex than the solid-propellant thruster. However, the flexibility of this device makes it suitable for operation at elevated thrust levels. This flexibility is achieved by varying the density of the gaseous propellant and varying the capacitor discharge rate through the accelerating load.

A new and radical electromagnetic con-

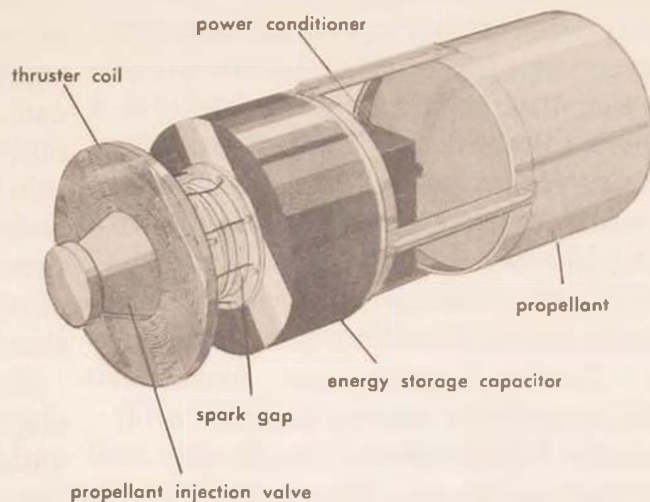

Figure 3. Pulsed inductive thruster

LES-6 thruster into the millipound regime. At this level, the solid-propellant thruster can perform other vital orbit maintenance functions.

The operation of the pulsed inductive thruster is analogous to that of an induction motor. (Figure 3) The propellant, Xenon, is one with conductive properties. After the propellant is sprayed over the face of the inductive load coil, the capacitor is discharged. The discharging capacitor creates a magnetic field. As this field diffuses into the ionized propellant, a current is induced in the propellant. The existence of both

cept presently under preliminary investigation is known as "magnetic field annihilation." This fascinating theory is based on the phenomenon occurring in solar flares and identifies a more efficient method of using electromagnetic energy as an acceleration mechanism. Solar flares appearing on the sun's surface are caused by bodies of hot, ionized gases coming together. The result is that hot gases (i.e., solar flares) are expelled outward from the sun's surface. Petschek first employed his theory of magnetic field annihilation in an effort to explain the vast amount of energy that had

been observed in solar flares.<sup>7</sup> Based on Petschek's theory, Charles Lee Dailey has advanced an idea for a magnetic field annihilation thruster.<sup>8</sup> The name of the theory derives from the hypothesis that magnetic fields annihilate one another in solar flare processes. The energy that had been stored is then totally transformed into the kinetic energy of the solar flare mass particles. By total utilization of the generated magnetic field in an electromagnetic thruster, it is believed that higher thruster efficiencies can be attained. This will provide pay-offs in terms of the amount of propellant and input electrical energy that are required to perform a certain mission.

Probably the most advanced electric thrusting concept presently under Air Force study is the utilization of the ambient atmosphere as thruster propellant. Gordon L. Cann, under AF contract, is determining if there are sufficient particles available at an altitude of 100-200 miles to be electromagnetically accelerated so as to overcome atmospheric drag.<sup>9</sup> If there are sufficient particles, the implications are awesome. This would essentially mean that a low-orbit satellite could be maintained indefinitely by electromagnetically accelerating the particles in the atmosphere to overcome drag. Thus, it would not be necessary to carry along propellant to perform this "secondary" propulsion function.

In summary, both electrostatic and electromagnetic systems are capable of attaining high specific impulse. The electrostatic systems are more efficient at low thrust levels and require less input energy for a specific mission. The electromagnetic systems have the advantages of simplicity of operation, applicability to spinning satellites, and the ability to extrapolate to high thrust levels reasonably. Both types of systems are in development. Questions yet to be answered regarding electric propulsion systems include lifetime and spacecraft in-

terference. Tests to date with the ion engine aboard the NASA spacecraft SERT-II and the solid-propellant pulsed plasma thruster aboard the spacecraft LES-6 indicate that electric thrusters do have the potential to perform orbital maintenance functions successfully and to accomplish repositioning functions in which time constraints are minimal. As more power becomes available for space applications, electric propulsion devices should proceed to even more ambitious functions.

### Military Space Applications

A major goal of military research and development is to increase satellite lifetimes significantly. Accomplishment of this feat can realize substantial savings in terms of dollars and manpower utilization. Extension in lifetime will require propulsion refinements. The development effort now proceeding in the electric propulsion area offers promise that the necessary propulsion improvements can be achieved.

Some typical USAF missions in space include communication relay, navigation aid, and data relay. Satellites performing these functions presently operate for not longer than five years.<sup>10</sup> Hawk and others have presented some conceivable propulsion functions, along with representative total impulses, which would allow some very ambitious missions of the above types to be performed over a seven-year life.<sup>11</sup> They considered the post-1975 time period as the earliest opportunity for incorporating electric propulsion systems into operational USAF satellites. Their findings are listed in Table I.

The propulsion functions listed in Table I are necessary for acquisition of the correct orbit, overcoming forces that would remove the satellite from the proper orbit, orienting the satellite for means of communication, etc., and performing a small re-



Function	Orbit	Total Impulse (lb-sec)
Attitude control	Sync Eq	1,000
E-W stationkeeping	Sync Eq	3,000
Initial acquisition	Sync Eq	5,000
Reposition ( $\Delta V = 200$ fps)	Sync Eq	12,000
N-S stationkeeping	Sync Eq	60,000
Control apsidal drift	$i = 30^\circ, e = 0.25^*$	100,000

\* $i$  is orbit inclination;  $e$  is orbit eccentricity.

Table 1. Propulsion functions and total impulse for 2000-pound satellite / seven-year life

positioning function. As can be seen, the performance of these functions requires large total impulses. Successful development of electric propulsion will enable extended life without degradation of the satellite mission.

With the advent of the space shuttle, another ideal mission for electric propulsion becomes identified. Through use of the shuttle, USAF satellites could be lifted to an altitude of approximately 100 miles. However, certain satellites for such purposes as communication can operate best from synchronous orbits—those occurring at approximately 20,000-mile altitudes and characterized by remaining fixed with respect to a point on earth. That is, the satellite in synchronous orbit and the earth rotate at the same rate, thus enabling two-way communication between the satellite and fixed antennas on earth.

The transitioning of a 1000-pound satellite from a 100-mile orbit to a 20,000-mile orbit would require approximately 365,000 pound-seconds of total impulse. Heavier satellites would require a correspondingly greater impulse. In this large total impulse regime, the high specific impulse furnished by electric propulsion devices is certainly attractive. As mentioned previously, the limitations on available satellite power mean that electric propulsion devices are presently thrust-limited. This thrust limitation

necessitates larger transition times. However, for many orbit-raising requirements, time consideration should be minimal. For these cases, a large payoff in propellant weight savings can be realized through the employment of electric propulsion.

Another advantage that electric propulsion presently can offer is in the area of very fine attitude control. The fact that the capability to point antennas very accurately permits significant reductions in transmitter power lends great impetus to the search for new methods of achieving the necessary degree of control. A likely candidate for this application is the pulsed plasma thruster. This type of thruster can provide very small average thrust levels for very short periods of time, with the result that a satellite can be rotated in terms of arc seconds. Possible competitors to the pulsed thruster are mechanical devices such as gyro-controlled platforms or momentum wheels. Whether or not these mechanical devices will have the necessary lifetime for long-duration satellite missions is under debate.

The employment of electric propulsion devices for high-total-impulse space missions will allow significant savings in terms of utilized propellant mass. Thus, a substantial payoff can be realized through longer satellite missions, launch weight savings, increased payload, or a combination of these. As man learns to harness more effectively the vast amounts of available energy, electric propulsion systems could provide the capability of allowing extensive space repositioning to be accomplished in a reasonable amount of time and for a reasonable expenditure of propellant.

#### Hypothetical Future Electric Propulsion Regimes

In his article entitled "The Relevance of Space," Arthur Kantrowitz strikingly points

out the payoff to be derived through the utilization of more efficient propulsion systems.<sup>12</sup> He indicates that, if the energy consumed in lifting payloads into space were used as efficiently as consumer electricity on the ground, the cost of the energy necessary to put a 6600-pound spacecraft into low orbit would be less than \$150. The high cost of space launches results partially from the relatively low energy available from chemical fuel, which causes the launching vehicle to be much greater in size and weight than the actual payload put into orbit. Through employment of very-high-thrust electric propulsion devices, the launching vehicle could conceivably be reduced to about the same size as the payload.

Once in space, the ability to operate at high thrust levels and correspondingly high specific impulses would enable the realization of sustained, large-scale maneuvering. At present, chemical rockets can rapidly maneuver on a relatively low total impulse basis. After that, their fuel will have been exhausted. The evolution of electric propulsion into the high thrust regime would enable rapid and sustained maneuvering.

The major impediment to the realization of high-thrust electric propulsion devices is the present lack of adequate energy sources for space applications. Solar arrays are presently thought capable of providing between 10 and 20 kilowatts of power. This level would allow fractions of a pound of thrust at a few thousand seconds specific impulse to be produced by an electric propulsion device. As mentioned earlier, this thrust level would allow accomplishment of certain repositioning maneuvers in which time constraints were minimal. At 50 to 100 pounds of thrust, electric propulsion devices would begin entering the rapid repositioning regime. To attain this level, approximately 10 megawatts of input power would be needed. This level represents a

multiple of the presently available power of approximately one thousand. Thus we are talking in terms of space power breakthroughs.

Should we be optimistic that these power breakthroughs can and will be achieved? I think so. The reason for this optimism is that man is presently being pressed to develop new energy sources. As Peter Glaser points out, the limitations on fossil and non-fossil fuels will force us to develop options for the future.<sup>13</sup> Hopefully, the technology developed to provide the necessary energy options will also allow us to make the desired advancements in space propulsion.

Adequate magnitudes of energy could be furnished to a spacecraft by two means. Energy sources, such as nuclear-electric devices, could be put aboard the craft. Alternatively, energy from a power plant could be beamed to the spacecraft. There is interest in each of these concepts at present.<sup>14</sup>

A development effort based on any of these concepts should concentrate on weight and size. At today's level of technology, C. L. Dailey estimates that an on-board energy system capable of supplying 10 megawatts of power would weigh about 80,000 pounds.<sup>15</sup> He also estimates that the receiving equipment necessary to implement the beaming concept would weigh about 40,000 pounds but with a greatly increased area requirement. The receiving equipment, which could be "rolled up" during launch, would need a deployed area encompassing about 210 meters on a side. Spacecraft relying on these energy systems could certainly be launched with a Saturn V into a low orbit. However, for purposes of faster response and greater maneuvering capability, it would be highly desirable to have systems reduced by a factor of 10 in weight and size.

Rough estimates of the possible availability of these energy sources have been made by several prominent individuals.



Layton estimates that an on-board nuclear power source could be ready for spacecraft utilization in about eight years at a cost of \$2 to \$3 billion.<sup>16</sup> Glaser and Krafft A. Ehrlicke, although not specifically thinking in terms of spacecraft applications, advocate the development of spatial power systems that could be used for a wide variety of functions.<sup>17</sup> Once deployed in space, these systems could furnish beamed energy to a spacecraft when rapid repositioning maneuvers were desired. Through utilization of the space shuttle, Glaser and Ehrlicke predict that their systems could be ready or near-ready by the 1990s.

Exactly what would be gained by operating in the previously mentioned thrust range of 50 to 100 pounds or alternatively using the available energy to achieve specific impulses as high as 30,000 seconds? The answer to this question is that many new repositioning regimes would become available to military spacecraft. For instance, it might be desirable to station a backup spacecraft in a certain orbit; then, if a certain primary satellite serving a critical function such as data relay became inoperative, the backup spacecraft would be repositioned by using the maximum thrust level. Alternatively, if it were only necessary to reposition slowly, then the higher specific impulse could be utilized at a greatly reduced rate of propellant consumption. It should be

remembered that input energy to an electric propulsion device can be traded off between thrust and specific impulse.

The idea of having a backup spacecraft in orbit would also be highly desirable for another reason. In case an unforeseen mission were to arise quickly, the backup spacecraft could be temporarily repositioned to undertake the new mission. It is the flexibility of this concept that could yield substantial payoffs.

The repositioning functions of interest would be orbit plane shifts, orbit raising or lowering, and position shifts in a certain orbit. Dailey has assessed the feasibility of performing large-scale orbital maneuvers in times of the order of a few days to a few months by means of a compact electromagnetic thrusting system.<sup>18</sup> The energy for this system is derived from a beamed source. Dailey's results are summarized in Table II.

The figures listed in Table II indicate that thrust levels in the 50- to 100-pound range do indeed begin to allow us to enter the regime of rapid repositioning, even for very large spacecraft. However, much is to be gained by moving up to thousands of pounds of thrust. Chemical rockets are already at this level, but with specific impulses in the 200- to 400-second range. Thus, chemical rockets are highly effective for relatively low total impulse maneuvers. The sustained

Function	Fuel Consumed (pounds)	Thrust (pounds)	Specific Impulse (seconds)	Time (days)
180° position change in low orbit	330	26.6	10,000	1.5
2400-mile orbit raise (low initial orbit)	25,000	55.5	2,000	9
	5,000	31.0	10,000	19
	2,500	15.5	20,000	35
90° orbit plane shift	25,000	45.7	4,375	26
	11,150	31.0	10,000	40
	4,167	10.3	30,000	112

Table II. Approximate repositioning times for an electromagnetic thruster operating in 50-100-pound thrust and/or high specific impulse regime. Ten-megawatt input power is assumed; spacecraft weight is 125,000 pounds. The difference between the power weight of 40,000 pounds and the spacecraft weight is comprised of the electromagnetic thruster configuration, propellant, structure, controls, and payload. These figures are based on estimated technology and would require the development of the power equipment and high-thrust electromagnetic device. (Data summarized from C. L. Dailey.)



maneuvering capability will require systems that can more efficiently utilize their propellant.

This discussion has concentrated on the payoffs that could be realized through the employment of high-thrust electromagnetic devices for repositioning. But how about the actual launching of vehicles by electromagnetic systems? As mentioned at the first of this section, the use of high specific impulse devices to perform the launching function could reduce the size of the launching vehicle to roughly the size of the payload. For example, to place a satellite into low orbit, an orbital velocity of approximately 8000 meters per second is required. If the launch vehicle propellant were given a specific impulse of approximately 2400 seconds, then the system at launch would weigh only about 1.4 times as much as the weight placed into orbit. If a chemical system operating at 400 seconds specific impulse were used, then the system at launch would weigh approximately  $7\frac{1}{2}$  times the weight placed into orbit.

Again, however, the bugaboo of the electric propulsion systems is power. Acceleration levels of approximately 8 g's would be desirable to place, say, a 1000-pound satellite into low orbit. If an electromagnetic thruster were tasked for the launch phase, then an input power of approximately  $1.67 \times 10^8$  watts would be required. This power supply would weigh approximately 1.3 million pounds. Thus, means must be devised either to greatly reduce the weight of power supplies or leave the vast majority of them on the ground.

These examples show that learning to harness the vast amount of energy in the universe effectively will be paramount to the continued refinement of electric propulsion. Whereas the previously discussed concepts to harness energy could be considered "classical," Alfvén and Kantrowitz are presently advocating some totally different ideas. In

the area of launching vehicles by electromagnetic means, Alfvén is advocating transfer of readily available power from a ground network to a spacecraft in much the same manner that lightning is transferred between a cloud and the ground. He is calling this concept "energy transfer à la Zeus."<sup>19</sup> The possible advantage of this concept would be that very little airborne weight would be chargeable to either the power or propellant required by the electromagnetic thrusters. As an alternative to this method, Kantrowitz feels that the use of lasers will appear as an important possibility in the next decade. He contends that nothing we now know would rule out transferring the needed amount of energy to a spacecraft via advanced laser technology.

In the area of space repositioning, Alfvén advocates "sailing in the solar winds." These winds are caused by disturbances on the surface of the sun and contain a great amount of electric power. The earth's magnetosphere extracts about  $10^{12}$  watts from the solar winds. If a spacecraft could extract even a small percentage of this magnitude, sizable thrust levels could be achieved. As Alfvén points out, extracting energy from solar winds could, in principle, give a spacecraft specific impulses of up to 40,000 seconds.<sup>20</sup> Thus, the potential exists to boost spacecraft up to 100 times as fast as the chemical rockets of today.

Concepts such as these, although still in the elementary thought stage, could someday allow us to enter into the operating regimes for which we are searching. They definitely deserve serious consideration.

ELECTRIC propulsion devices now appear ideal for low-thrust, large-total-impulse space missions and missions in which spacecraft pointing must be very accurate. As more power becomes available, it is conceivable that high-thrust electric propul-

sion devices could become a reality. The advantages of elevating electric thrusters into the high-thrust regime would be that sustained, rapid maneuvering in space would be possible and the costs of spacecraft launches could be reduced. To move into the high-thrust regime, many times the presently available power will be required. The task will undoubtedly be very

difficult. Yet all the significant technological breakthroughs of the past have required their fair share of effort. If the same amount of effort is allocated to achieving our high-thrust electric propulsion goals, I feel the necessary breakthroughs will come. I believe the propulsion department of the patent office is going to be busy for many years to come.

*Air Force Rocket Propulsion Laboratory*

#### Notes

1. Hannes Alfvén, "Spacecraft Propulsion: New Methods," *Science*, 14 April 1972.
2. Arthur Kantrowitz, "The Relevance of Space," *Bulletin of Atomic Science*, April 1971.
3. T. O. Dobbins, "Thermodynamics of Rocket Propulsion and Theoretical Evaluation of Some Prototype Propellant Combustions," Wright Air Development Center Tech Report 59-757, December 1959.
4. Daniel S. Goldin, personal communication.
5. Hughes Aircraft Company, FRUSA report presented at Space and Missile Systems Organization (SAMSO), December 1971.
6. Alfvén, *op. cit.*
7. Harry Petschek, "Magnetic Field Annihilation," Proceedings of AAS-NASA Symposium on Physics of Solar Flares, NASA SP-50, 1965.
8. Charles Lee Dailey, "Magnetic Field Annihilation of Plasmas for Advanced Engine Design," AFOSR TR-71-0328, 31 March 1971.
9. Peter Glaser, as interviewed in *Astronautics and Aeronautics*, February 1973, p. 10.
10. Ed Barth, personal communication.
11. Clark W. Hawk *et al.*, "System Study of Electric Propulsion for Military Space Vehicles," AIAA paper nr 72-493, April 1972.
12. *Bulletin of Atomic Science*, April 1971.
13. Peter Glaser, "A New View of Solar Energy," presented at 1971 Intersociety Energy Conversion Engineering Conference, Boston, Massachusetts, August 1971.
14. J. Wilhans and K. Kirby, "Exploratory Investigation of an Electric Power Plant Utilizing a Gaseous Core Reactor with MHD Conversion," presented at the Nuclear Power for Tomorrow Conference sponsored by the American Nuclear Society, 24 August 1972; W. Brown, "Transportation of Energy by Microwave Beam," procedures of the Intersociety Energy Conversion Engineering Conference, August 1971.
15. Dailey, personal communication.
16. J. P. Layton, personal communication.
17. Glaser, *Astronautics and Aeronautics*; K. Ehrcke.
18. Dailey, personal communication.
19. Alfvén, *op. cit.*
20. *Ibid.*



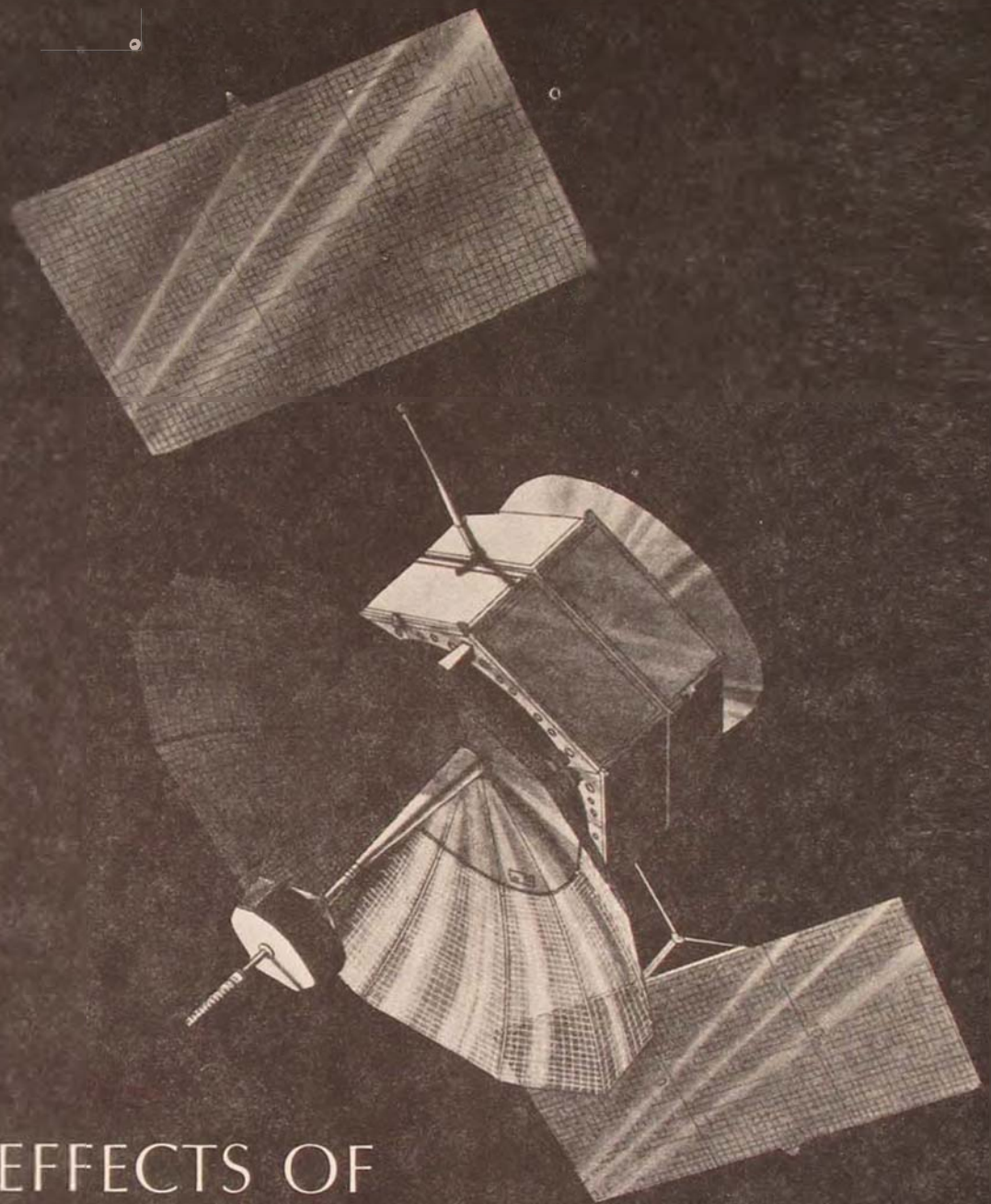

# THE EFFECTS OF IONOSPHERIC SCINTILLATION ON SATELLITE COMMUNICATIONS

ALLEN L. JOHNSON

**S**OMETIME in the not too distant future, a modern SAC bomber, flying a routine mission, reports aircraft status to the command post via UHF satellite communication relay link without complication or problem. But toward the end of the mission the aircraft develops an emer-

gency. A crewman punches the buttons to send a "Mayday" call, with aircraft position information, via the satellite link. The command post receives the message, but for some reason it is unreadable. Where has the system failed? Is it an equipment problem or maybe an operator error? No, the answer is probably "generation gap."

Each new generation of communications—from semaphores to smoke signals, to the wireless, and now to satellite communications—brings on a set of unique problems. While the smoke signal provided greater communication distance than the semaphore, it was susceptible to wind and rain effects. The wireless overcame these obstacles but was affected by multipath and static. Satellite communication solved multipath and static but generated a set of its own problems. With the advent of the Air Force Satellite Communication System and the Navy's FLEETSATCOM system, the problems of satellite communications are being recognized as operational limitations of a new generation of communication technology.

One of the new problems that must be contended with is "ionospheric scintillation." Scintillation of a star is the twinkling that results from light rays bending as they pass through the inhomogeneous atmosphere. Scintillation of a radio signal is the "twinkling" that results from radio waves passing through an inhomogeneous ionosphere. This twinkling can cause erratic reception of a radio signal and can disrupt vital communications for hours.

In order to develop techniques that circumvent the problems associated with ionospheric scintillation, an effective model must be developed. Much previous work has been done in this area, especially by radio astronomers. But, in general, the models fail to describe fully all parameters associated with observed scintillation.

The particular type of scintillation ob-

served is due to the behavior of the ionosphere. More specifically, ionospheric scintillation appears to be due to irregularities in the F layer of the ionosphere. This layer, which extends from 60 to 500 miles above the earth's surface, does not appear to be completely uniform. Shortly after sunset small irregularities in the ionosphere are amplified as the ions interact with the magnetic lines of force. It is believed this interaction causes the ions to concentrate in cylindrical shapes that align along the magnetic line of force. These cylinders are typically 100 to 1000 feet in diameter and 10 to 100 miles long.

The behavior of ionospheric irregularities is a very complex function of a number of variables. The gross factors that appear to influence the behavior include location on the earth, sun spot activity, season, and time of day. A host of minor factors also affect these irregularities. The ionospheric scintillation model becomes more complex and less predictable as a result of the large number of variables.

While ionospheric scintillation occurs all over the globe, scintillation associated with the equatorial region has received the most attention for a number of reasons. First, the depth of fading caused by equatorial ionospheric scintillation is generally greater than for mid-latitudes or polar regions. The fading often reduces the signal to one one-thousandth of its unfaded value. A second reason is that there is more opportunity to observe the effects in the equatorial region, as it is more densely populated than the polar region. Since the satellite is starting to play a progressively greater role in military communication and navigation, the Air Force is funding equatorial testing. Also, since the effects of scintillation are less in the mid-latitude and polar regions, it is generally agreed that, once the scintillation problem is solved in the equatorial region, these solutions can be used in other regions.



Researchers have learned much from the host of experiments that have been performed. It is known that equatorial scintillation activity increases during the spring and fall equinox periods and exhibits a broad decrease during the summer and winter solstice periods. The scintillation is primarily a nighttime effect.

The onset of scintillation fading normally begins abruptly one to two hours after sunset. As the radio waves penetrate the disturbed region, they are focused by the high discontinuities resulting from ionospheric irregularities. (Figure 1) These irregularities tend to drift in an east-west direction, causing the fading to drift by a ground or

airborne terminal. A disturbed ionosphere area as small as 25 miles in diameter or as large as 2000 miles in diameter drifts at speeds approaching 100 miles per hour. Within this disturbed area are many discontinuities or fade-causing irregularities. A ground terminal sees the effect as slow fading, during which the station may be blanked out for several seconds each time a discontinuity goes by. An airborne terminal generally is moving several times as fast as the irregularities and therefore sees a fade that is much shorter in duration. Since the disturbed area varies greatly in size, the periodic fading may occur for minutes or hours as the irregularities pass by. The effect

*The USAF Aeronautical Systems Division's C-135 test aircraft used in taking scintillation measurements. Several UHF antennas used for the measurements can be seen on the top and side of the aircraft. The white radome on top contains a super-high-frequency (SHF) antenna system for satellite communications. The aircraft was flown to Guam for the scintillation measurements from its home base at Wright-Patterson AFB, Ohio.*

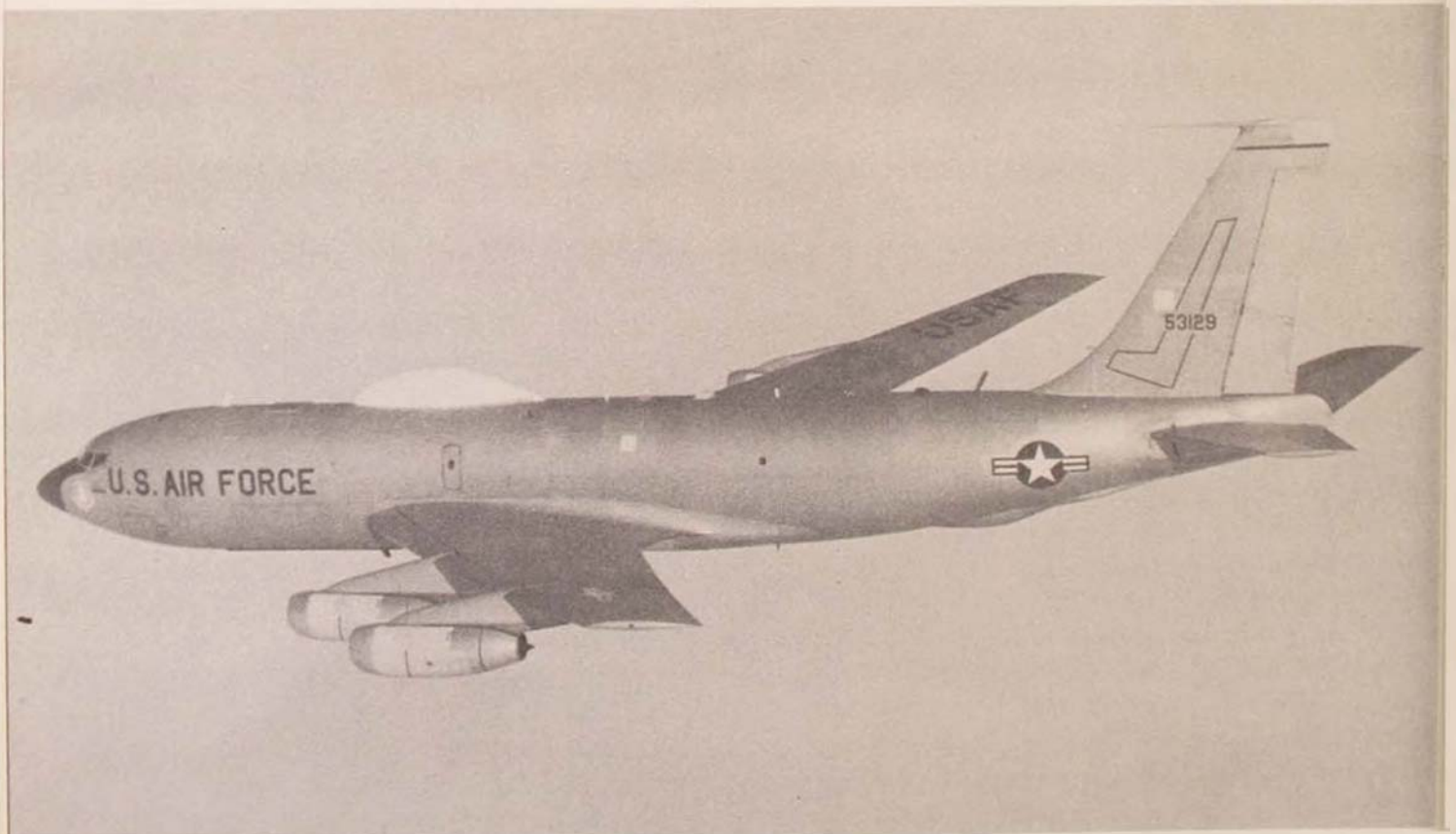

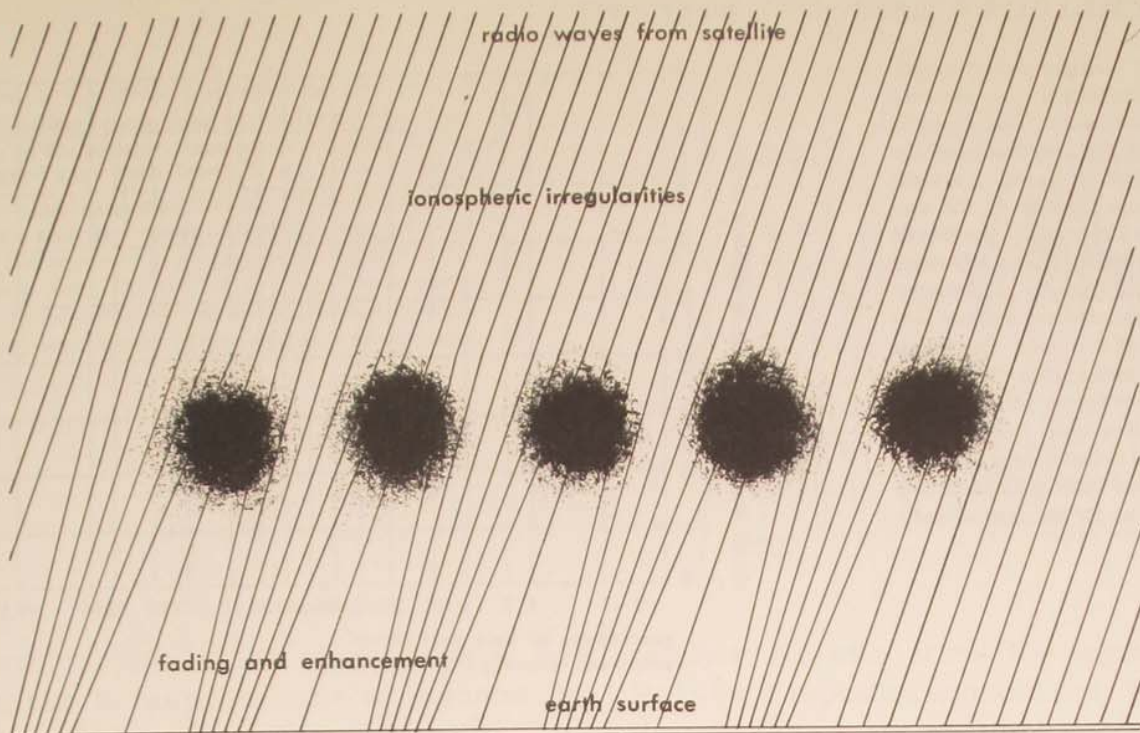

Figure 1. The ionospheric scintillation fading model. The equatorial ionosphere (200-mile altitude) contains high ion concentrations in horizontal cylinders 500 feet in diameter and tens of miles long, aligned in a north-south direction. The signals from a communication satellite are focused as they pass through the ionosphere. Fade and enhanced areas occur on the earth as a result of this focusing. The ionospheric irregularities—and consequently the fading—drift in an east-west direction.

of scintillation is most pronounced for those frequencies normally used for aircraft communications (HF, VHF, and UHF). The scintillation fading characteristically begins abruptly and ends abruptly. (Figure 2)

The original scintillation testing was performed at ground stations. More recent experiments have involved specially instrumented aircraft (see photo), working in conjunction with ground stations to uncover

Figure 2. A recording of the signal received in an airborne terminal from a satellite shows the abrupt end of UHF ionospheric scintillation fading. Time starts at the right and increases to the left. At the start of the segment shown, the fading is greater than 25 db (from -115 dbm to -140 dbm). Duration of an individual fade is about one second. Toward the left side of the chart the fading goes from maximum to none in a period of ten seconds, demonstrating the abrupt end of the fading condition.

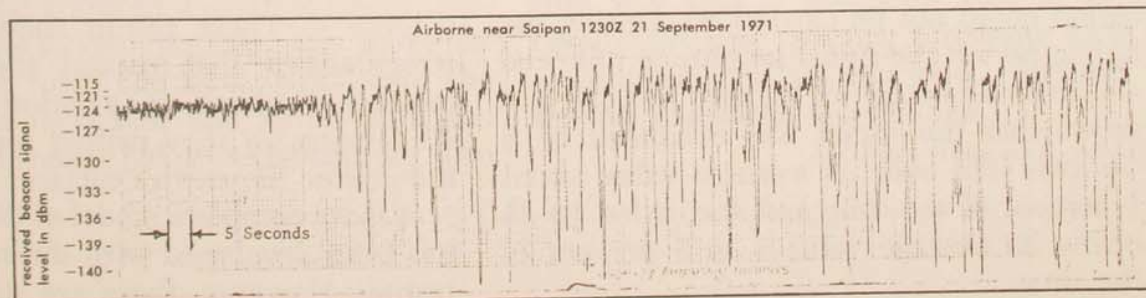
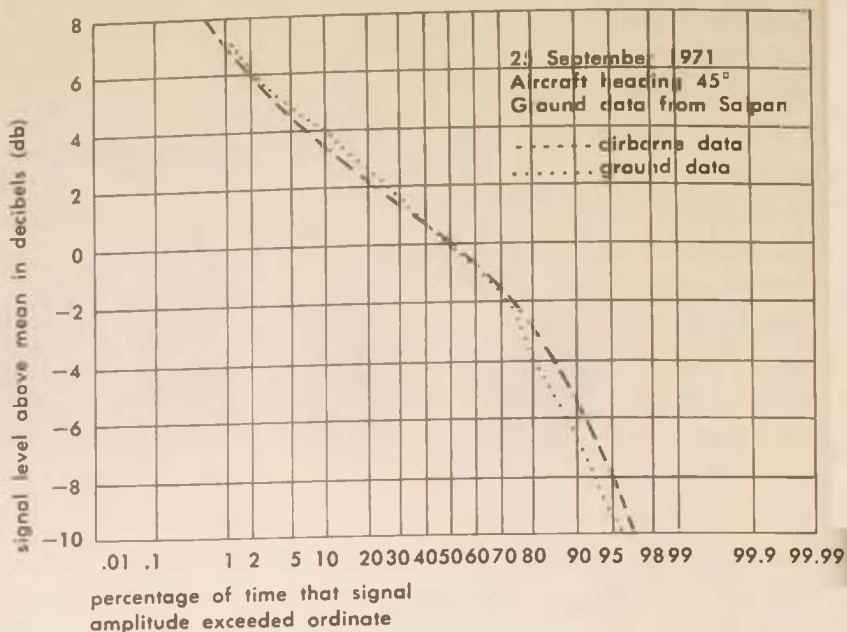



Figure 3. Comparison of amplitude distribution for airborne and ground data. This figure is a plot of the amplitude of the signal received during a scintillation fade, similar to the one shown in Figure 2. If the amplitude is sampled about 100 times per second for the five-minute fade period, the cumulative percentage of the time the signal was at various levels follows the plot of this figure. The curve for the airborne data taken in the same area and at the same time as the ground data is statistically the same as for the ground data.



problems unique to the mobile terminal. By coordinating the data at the airborne and ground stations, we have developed a clearer picture of the ionospheric model.

In a recent joint Air Force/Navy test in the western Pacific, airborne and ground data were collected from the 250 megahertz (MHz) downlink beacon signal from the TACSAT satellite. Severe fading was recorded on 12 of the 17 night test periods. During about 7 percent of the total time, the fading was severe enough to disrupt normal satellite communications. This averaged more than 1½ hours a day, which could constitute a serious operational problem. During the severe fading period the signal did not always remain in a faded condition but went through periodic fade and enhancement at such a rate that normal communication could not be carried on. During the fading period the signal amplitude followed a curve, depicted in Figure 3. This plot shows that the signal was enhanced by 8 decibels (db) over its average value about 1 percent of the time and was faded 10 db below its average value 3 to 5 percent of the time.

In order to confirm the ionospheric scintillation model and to determine the length of time an individual irregularity remained identifiable, data were recorded simultaneously in a ground and airborne terminal in the same vicinity. As predicted, the data showed the fading in the aircraft to be identical to the fading occurring on the ground if the effect of the aircraft velocity was considered. To do this airborne data were digitized and "slowed down." With computer analysis, various amounts of "slowdown" were tried as the airborne data were compared with ground data taken in the same area. Finally, the correct "slowdown" was determined, and good correlation of the airborne and ground data was obtained by comparing the original ground recording with the "slowed down" airborne data. (Figure 4) These results showed that the irregularities that caused the fading remained "coherent" for a period of more than 10 minutes as they drifted some 10 to 20 miles over the earth's surface.

A more complete model of the ionosphere has been developed with the results of this testing. However, there are still many un-



Figure 4. Comparison of airborne and ground scintillation fading data. The airborne fade data, taken in the vicinity of the ground station, display a much faster fade rate than the ground fading because of the aircraft velocity. If the effect of the aircraft velocity is removed from the data, the exact fade that occurred on the ground can be seen in the airborne data. The two sets of data correlate very well on the left-hand side of the plot but start becoming uncorrelated at the right side of the data.

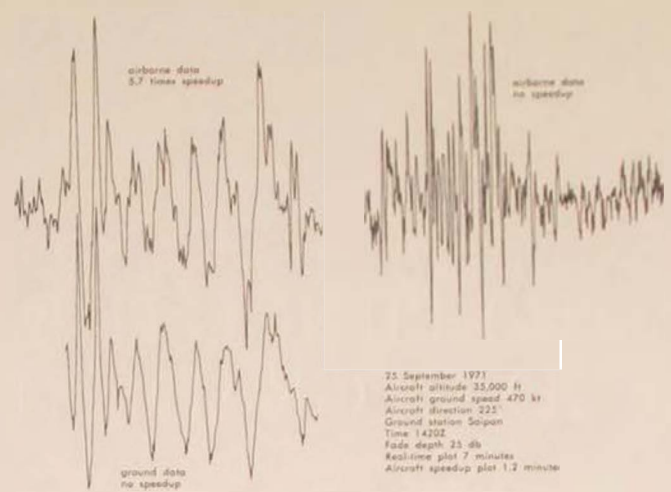

known factors in the model, which will continue to surprise users of communication satellites. Using the new model, how do we propose to overcome the effects of ionospheric scintillation fading? It appears that frequency diversity, the technique of transmitting the same information on two frequencies, will not improve the communication reliability. Likewise, using two antennas to receive the signal would require antenna separations of several thousand feet to improve the reception. These distances are clearly impractical on an aircraft. One technique that does offer promise is message repeating or very long error correction coding. When a communication terminal is in a disturbed area and experiencing periodic fading, the communication signal is lost for only 10 to 25 percent of the time. The remainder of the time the signal is normal amplitude or enhanced. A simple repeat technique would be to store the message and transmit a small segment, possibly a one-second portion, for 10 to 20 times in a row. The next segment of the message is then sent and so on until the complete message has been transmitted. The

receiver, likewise, stores the segments and looks for a repeated segment that would get through during the unfaded portion of the time. These recognized portions are recombined and represent the complete message. Such a technique slows down message transmission rate by the number of times the segments are repeated but should provide a reliable means of overcoming the fading.

In the future the satellite will play a more prominent role in military and civilian communication and navigation systems. Air traffic control satellite communication systems will provide a reliable means for monitoring aircraft status and location during overwater flights. Military systems such as the Air Force Satellite Communication System will allow positive control of the airborne forces worldwide. With satellite communications come the phenomena of ionospheric scintillation fading. Since satellites will play a dominant role in future communication systems, problems such as ionospheric scintillation will continue to receive considerable attention.

*Air Force Avionics Laboratory*

PENS  
TO PIERCE THE MIGHTY  
AND DEGRADE THE SWORD

BRIGADIER GENERAL NOEL F. PARRISH, USAF (RET)

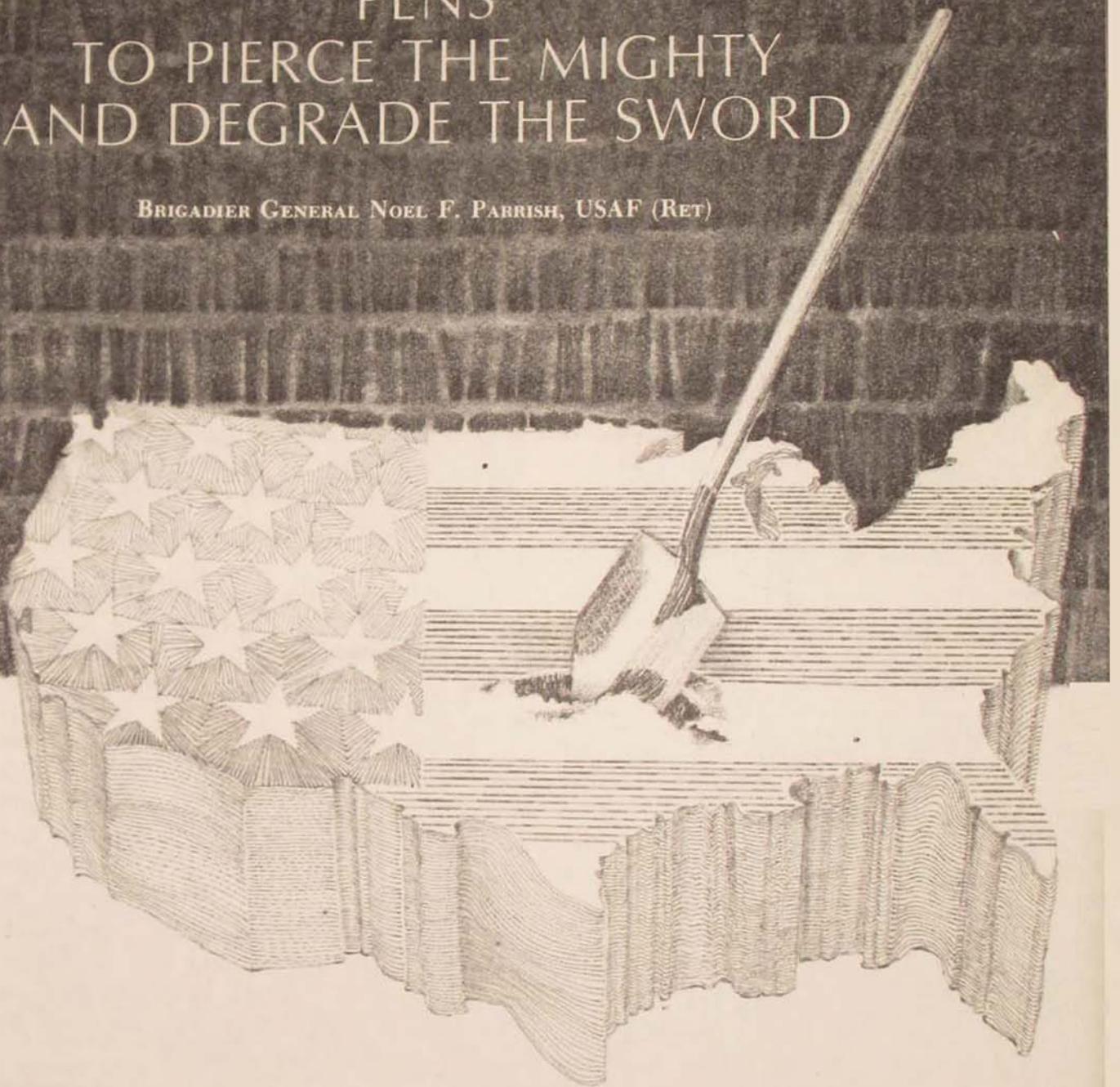

*"... Barnet and his fellows dig their native land  
only to turn up the dirt."*



ONE of the most understandable of great contemporary poets, W. H. Auden, writes in his new *Epistle to a Godson*: "You don't need me to tell you what's going on: the ochlocratic media, joint with under-the-dryer gossip, process and vent without intermission all to-day's ugly secrets. . . . if what is to happen occurs according to what Thucydides defined as 'human', we've had it, are in for a disaster that no four-letter words will tardy."

Auden was not referring to Richard J. Barnet's recent book, *Roots of War*, nor to the published and broadcast work of Barnet's sources and ideological colleagues who are the authors of similar products. Yet, since these include Neil Sheehan, *The Pentagon Papers*; Tristram Coffin, *The Armed Society*; Ralph Stavins, Richard J. Barnet, and Marcus Raskin, *Washington Plans an Aggressive War*; Robert Crichton, "Our Air War," in the *New York Review of Books* (January 4, 1968, pp. 3-5); William Appleman Williams, *The Roots of the Modern American Empire* and *The Tragedy of American Diplomacy*; Seymour Melman, *Our Depleted Society* and *Pentagon Capitalism*;

Gabriel Kolko, *The Politics of War*; Noam Chomsky, *American Power and the New Mandarins*; William Fulbright, *The Pentagon Propaganda Machine*; and finally the producers of the CBS TV extravaganza, "The Selling of the Pentagon," it is clear that they all relate to Auden's widely shared dismay.

Not all these men agree with each other on every issue, nor do they deal always with "ugly secrets"; but they all flaunt a haughty indignation that might be called "the new school tie." Their comments on past and present American difficulties are not usually couched in four-letter words, but they are frequently so translated at campuses and conventions. To their credit it should be said that these writers and speakers do not themselves advocate mob rule (ochlocracy), although they and the media seem at times to encourage it. In most cases these disconsolate specialists in adversity do not fix blame on fate or on supernatural forces, as Thucydides did not. They ascribe responsibility to universal human nature as Thucydides did. They blame only the United States government—sometimes all government—and all its agents.



In *Roots of War* (Atheneum, 1972), Richard Barnet presents a splendid example of the common tendency among the writers and "communicators" in question to focus their censure on a small but influential group of administrators who work in large buildings on opposite banks of the Potomac River. These men are labeled by Barnet as "the national security managers." He says there have been 339 men and a woman in this category since World War II. There is some confusion in Barnet's and similar writings as to whether these managerial types are representative of "American society," which also takes many licks. There is even more confusion as to whether these blame-worthy State Departmentalists and E-ring Pentagonians are outright malicious or just clumsy; whether they are misguided or misguiding; knowing criminals or miserable carriers of some psychic American social disease; and, finally, whether they are all too human or just plain inhuman.

An example of this confusion is provided by E. B. Tompkins's laudatory review in the once prestigious *Saturday Review*, which interprets Barnet's description of these na-

---

*"... these writers and speakers do not themselves advocate mob rule (ochlocracy), although they and the media seem at times to encourage it."*

---

tional security managers: "Drawn primarily from law and banking, they were well educated and power-hungry. Barnet views them as amoral, insensitive, ruthless, and hypocritical men with a predilection for violence and fascinated by lethal technology." Tompkins admits the picture may be overdrawn.

On the other hand, prolific foreign policy critic Ronald Steel, lengthily reviewing and approving Barnet's book in the recently famous *New York Times*, says that while the Pentagon managers "decide from their desks and push buttons which governments shall be overthrown and which nations destroyed . . . they are, Barnet holds, deeply moral men who are convinced that what they are doing is best for the nation and by extension, best for the world. They are always saying so and there is no reason to believe they do not mean it." Steel, who might well be considered something of a competitor in the increasingly crowded occupation of damning both banks of the Potomac, goes on to praise Barnet as "one of our most perceptive young political analysts. *Roots of War* is an eloquent, important and timely study that breaks new ground. It clarifies the issues, stimulates the mind and enriches the debate it is certain to trigger."

Although Steel's final sentence seems heavy on the trigger, Barnet can scarcely top this accolade when he reviews Steel's next book, a not unlikely circumstance since gentlemen of this critical school are customarily asked by friendly editors to comment upon each other. The claim that the book "clarifies the issues" is questionable. There is a crucial difference of opinion between admiring commentators on the central point of whether the villainous national security managers chose those black hats or just picked them up by mistake. Careful reading indicates that despite what the *Library Journal* calls Barnet's tendency to be "rambling and repetitious," his picture of the powerful Pentagonians is definitely that which the *Saturday Review* commentator saw as "overdrawn." Barnet had his tongue buried in his cheek when, like Shakespeare's Mark Antony at Caesar's funeral, he praised these men as honorable and upright—only to add that their children call them "up-tight." Even as he credits them with nor-

mally happy marriages and sexuality, Barnet finds this most surprising, since Hitler was sexually abnormal.

The other principal point of variance among Barnet's sympathetic interpreters is whether the "lawyers and bankers" who ever since World War II have been responsible for, as the once judicious *Library Journal* puts it, "America's persisting plans to engage in permanent war in the name of permanent peace," are freaks or just typically ailing members of our sick society. William Pfaff, a widely published associate of Herman Kahn, writes in *Book World* that Barnet's is the "best book we possess on the subject . . . of the cold war." He finds it "convincing" and says these national security managers "were no narrow elite. They were representative of their generation." On the other hand a reviewer in the *Nation* sees Barnet as searching for the reason "why this nation with its conviction that it means only to do good, has brought such misery to the world in the last quarter century," and along with most other commentators he sees Barnet's "critique of the national security managers" as the most important clue.

Much of the confusion on this latter point arises from Barnet's generosity with blame. Since blame is his profession, so eager is he to spread it that he and his fellow "new left" interpreters of past and present now make an entire nation the target of their blunderbuss charge. Somewhat at variance with Voltaire's advice to cultivate one's own garden, Barnet and his fellows dig their native land only to turn up the dirt. No probing is necessary for the "roots of war" since he feels them all around him. In a society as rotten as he finds ours, it becomes difficult to fix upon the source of infection. Nevertheless, despite the confusion he causes among even his most eager readers, Barnet indicates that in the country of mindless villains the single-minded homicidal villain

is truly a prince. The most princely Lucifers in his inferno are the "best and brightest" sons of privilege and costly universities who descended upon Washington with the brothers Kennedy to "plot aggressive war."

As most of the admiring commentators on *Roots of War* have observed, the chapters on the "crisis managers who created the crises they mismanaged during the Kennedy-Johnson era are the book's principal contribution." With all reluctance, it must be admitted that they are a contribution. Barnet and his friendly source (everybody's source for the saddest items of this

---

*... Barnet views [national security managers] as amoral, insensitive, ruthless, and hypocritical men with a predilection for violence and fascinated by lethal technology."*

---

unhappy period, Daniel Ellsberg) were themselves among the "best and brightest." They were among the first to leap into the Kennedy dragnet for new and unprecedented talent.

Despite Ellsberg's penchant for solitary labor at night and his singular productivity with a photocopy machine, Barnet's is much the superior talent. Unlike Ellsberg and other hawk-dove mutations who screamed with the eagles before turning pigeon, Barnet appears to have been reasonably consistent as a man of sincere pacifist inclinations from the start. Like other job-jumpers culled from the Eastern ivy, Barnet managed to spend enough time in the Pentagon or thereabouts to gain the usual escalator-rider's clause in his record: "consultant to the Department of Defense." Yet he seems



to have spent most of his time on disarmament, in the State Department and the U.S. Arms Control and Disarmament Agency. Possessing acute powers of observation and a keen cynicism behind his barrage of utopian slogans, Barnet saw and came to describe clearly his fellow members of the Kennedy intellectual elite at their dismal worst. That high-level group's management of the Vietnam effort in the early 1960s was so miserable in its results that few now rise in defense or explanation. Barnet's observations offer a bitter but thoughtful foretaste of the coming flood of literature on how it could possibly have happened.

As Barnet reports it, the great issue repeated throughout Kennedy's campaign was America's falling prestige. The Eisenhower administration was said to be "made up of miserly old men . . . the torch must now be passed to the young and vigorous who would fight the Communists with the courage and subtlety so lacking in the quiet clubhouse atmosphere of the Eisenhower White House."

The most damning phrase in the Kennedy lexicon, as Theodore White observed, was to call a man "ordinary" or to describe him as "common." Those who have listened more than once to discourses by McGeorge Bundy, Dean Rusk, Robert McNamara, or second-level personalities such as Alain Enthoven and Adam Yarmolinsky, will understand Barnet's description of their attitude in Calvinist terms: "They are the elect; . . . The arrogance so characteristic of the Kennedy advisers, a quality that made it so easy for them to dismiss unwelcome advice by dismissing those who proffered it, was the pride of the men who believed that they were the chosen."

One such speech, not mentioned by Barnet, was Adam Yarmolinsky's appearance before a capacity audience at the University of Colorado, which even his sponsor characterized as arrogant. Yarmolinsky

boasted that his personal role in selecting Kennedy appointees was to find "liberals" who were "tough" because toughness in all appointees was prescribed as the indispensable quality. Barnet now says some of these appointees, "looking back on their experience, talk about the 'hairy chest syndrome.'" In such an atmosphere, "Bureaucratic *machismo* is cultivated in hundreds of little ways. There is the style of talking to a subordinate—the driving command masked by superficial informality—or to a superior—fact-loaded, quantitative, gutsy. The Kennedy operators, particularly, cultivated a machine-gun delivery. . . . Speed reading too became a kind of badge of prowess. To be an operator is to be active in 'putting out fires,' . . . The ambitious and successful bureaucrat . . . specializes in the crisp, uncomplicated, usually mechanistic analysis of a problem . . ."

Seldom if ever in modern history has so powerful a group of men suddenly cultivated so self-conscious a "style." Not surprisingly, the first to be taken in by the new-establishment style were the traditionally skeptical and "tough-minded" newsmen. Their favorite word for these smooth yet stern performers was "steely": "McNamara had a steel-trap mind, McGeorge Bundy had steely nerves, etcetera." McNamara, appropriately pedestaled on an automobile, shouted at Harvard students, "I am tougher than you are." Barnet calls McNamara "the leading specimen of *homo mathematicus* . . . always looking for the facts, usually the wrong facts." He first broke others and finally himself with overwork and "was by the time he was relieved from office given to weeping in public."

Since the key to all value judgments was measurement and since a manager's output could scarcely be measured, prestige was measured by effort. For the Kennedy crop of ivy-clad professors, suddenly "fatigue became a badge of importance. Officials could



measure their significance by the demands their office made on their time. The favorite word of the self-important bureaucrat to describe his immediate plans on leaving office is 'to decompress.' " This charade of pretentious dynamism led directly toward the supercharged push to "finish," not to say win, an obviously endemic struggle in the ever resistant jungle of Vietnam.

Perhaps the most sacrificial figure, for whom even the Kennedys showed less respect than for anyone else except Vice President Lyndon Johnson, was Dean Rusk, who, after a seemingly interminable period in office, finally left "broke and unemployed." Why did he and others, such as the wealthy McGeorge Bundy and Robert S. McNamara, who gained nothing but dubious fame, endure all these strains, these "dreary meetings and sleepless nights"? Barnet quotes one unnamed "manager's" explanation: "Playing for high stakes."

This seems a vastly oversimple answer, especially for a whole group. Barnet goes on to say that, having tasted "Promethean power," they found it difficult to go back to "corporate bonds, . . . making raincoats, lecturing students, . . . In the Kennedy era they called themselves 'crisis managers' . . . their 'finest hour,' as many of them have written, was the Cuban missile crisis, . . . Like Henry V on the eve of the battle of Agincourt, the modern militarized civilian believes that he will be remembered and measured by the great contests in which he participates. . . . His tests are, of course, not tests of bravery but of toughness. . . ."

Anyone who witnessed at too close hand the openly cultivated and often ruthless *machismo* (Irish Mafia type) of these years may readily approve Barnet's designation of Kennedy himself as supremely responsible for the early misjudgments and blameful blunders of the Vietnam involvement. Evidence is cited which came, apparently, from the Ellsberg xeroxes. Barnet accepts

Ralph L. Stavins's designation of "Kennedy's Private War" (*New York Review of Books*, July 22, 1971), largely because of Kennedy's instructions, to national security agencies shortly after taking office, to "make every possible effort to launch guerrilla operations in Viet-Minh territory at the earliest possible time."

This and other evidence is said to show that actions against North Vietnam and in

---

*". . . whether the villainous national security managers chose those black hats or just picked them up by mistake."*

---

Laos, ostensibly to stop infiltration, were unjustified, since there was no infiltration, but the case as he presents it briefly here is inconclusive. More convincing are quotes from Arthur Schlesinger and Theodore Sorensen, Kennedy's house "intellectuals," who wrote their own more or less balanced accounts of various "secrets," which are in some ways superior to stolen documents selectively presented.

Sorensen revealed that even Maxwell Taylor, the Billy Graham of the early Counterinsurgency Faith, had stipulated that 8000 *regular* U.S. troops also would be needed if the original guerrilla operations were to have a chance of success. Yet Kennedy turned Taylor down, possibly because the Joint Chiefs of Staff agreed with him, and continued his own Jungle Jim strategy.

General Taylor, as Chief of Staff of the Army under Eisenhower, had served as Kennedy's man in the Eisenhower camp, and in fact the Kennedy brothers had sometimes visited Taylor in his quarters at Fort Myer, privately, under the purposely inconspicuous guidance of Senator Stuart

Symington. A considerable portion of Kennedy's campaign attacks against Eisenhower's military policies reflected Taylor's inside information and his official rebuttal against those policies. Eisenhower had repeatedly rejected Taylor's continuing requests for more money to fight future "brushfire wars"; but Kennedy was converted to the rather vague theory of "flexible response," which has turned out, as most military men vainly warned, to be considerably more flexible in all respects than was originally meant by the ambiguous "brushfire" slogan. Barnet condenses the story now becoming familiar: Kennedy came to office convinced of the importance of the "Third World" whose "fate would be decided by the ordeal of guerrilla warfare. Shortly after his inauguration he appointed Taylor a special White House Assistant and put him in charge of 'Special Group Counterinsurgency.'" In this new enthusiasm, Kennedy was supported by Walt Rostow and also by "the energetic commitment of his brother Robert." He "vigorously backed those bureaucracies committed to unconventional warfare and personally restored the Green Beret" as the symbol of a new elite force, a sort of "President's own" force, against

*... Since blame is his profession . . . [Barnet] and his fellow 'new left' interpreters of past and present now make an entire nation the target of their blunderbuss charge."*

---

Army opposition. The President "was briefed on the euphoric literature on counter-guerrilla warfare then beginning to emerge from the CIA-sponsored research in leading

universities, and turned his personal attention to improving the technology of guerrilla warfare. At his carved oak desk he pored over the design of a new sneaker for America's jungle warriors."

All of this fits well into other pictures developed from previously revealed or "news leaked" sources and especially the lengthy works of Sorensen and Schlesinger, who wrote laudatory accounts of Kennedy's deep personal involvement in the events of Vietnam before the military "newthink" that he decreed was finally seen leading to a dead end. Maxwell Taylor's memoirs depict Kennedy, after being shown the promised land of "flexibility," as taking his cues from supercharged activists, such as Roger Hilsman, who were more committed to the jungle than was Taylor himself. He liked their spirit as they sought to rescue failing doctrines through increasingly desperate operations.

Inexperienced in administration, Kennedy failed to recognize the chain-reaction effect created by his decree that enthusiasm for the new cause in all the services be used as a criterion for promotion and that skeptics be removed from areas of influence. McNamara, who had come into office even more ignorant of military matters than was Kennedy, had no ideas or principles of his own other than to establish himself as the toughest possible executor of the Presidential will. Armored in layers of charts, graphs, and linear projections, behind a barrage of self-convincing statistics gathered by all the overworked staffs of the Pentagon, he overawed both the press and the Congress so completely that the pleased President spoke of making him Secretary of State.

It now appears that the thoughtful and principled Rusk was more influential, for good or ill, than the man of numbers whose true function was that of a cipher, blankly extending and multiplying the thoughts and plans of others. But it is impossible for



a man of such prominence as McNamara to function in a conceptual vacuum. Who was his principal idea man? In Barnet's account, another figure emerges rather ominously from previous obscurity, John T. McNaughton, who died in the crash of an airliner years ago and is no more able to defend himself today than is the living McNamara. McNaughton's xeroxed memoranda show him writing of "symbolic" deaths and of the importance of "spilling American blood" in Vietnam. He seems to have taken more seriously than most of the staff Kennedy's reported instructions to read the works of Machiavelli. Some of his "hairy-chested" working papers speak of the war as being fought almost entirely for American interests rather than to help the Vietnamese, and he wondered how to provoke North Vietnamese reactions so we could retaliate. Barnet calls him "McNamara's trusted lieutenant" and his "leading thinker on the war." McNaughton is reported to have radiated toughness in all directions and to have been more disliked than his boss, yet there is a strange circumstance about his caustic writing that bears notice.

Working papers, in the Pentagon at least, are often written by assistants. McNaughton's assistant was none other than Daniel Ellsberg himself, who, it will be remembered, was once so exhibitionist a hawk that he had himself photographed in the act of pretending to be a machine gunner at the front. So we have in McNaughton's notes the "bloodiest" ideas, with McNaughton dead and his supersecret memoranda now broadcast by his former trusted assistant. The question of authorship arises. What was a bright, informed, and overdedicated mind such as Ellsberg's doing to assist McNaughton if not at least participating in the writing of working papers? It appears possible that Ellsberg the dove, in his nightly vigils over the secret xerox

machine, was immortalizing some earlier work of Ellsberg the hawk, ghost-written for his maligned and now dead boss!

The unknown is not more fantastic than the known, if we are to believe one of Ellsberg's own stories as told by Barnet:

"In September 1964 Assistant Secretary of Defense John T. McNaughton asked his assistant Daniel Ellsberg to look into what losing in Vietnam would mean. 'You realize,' Ellsberg recalls him saying, 'to work on this subject is to sign your own death warrant.' McNaughton did his own typing on this high-risk assignment." It may be futile to wonder who did the typing on less fatal memoranda. In any case it seems sadly ironic that this story, if true, shows poor McNaughton mistrusting his no-doubt loyal secretaries and trusting Daniel Ellsberg.

In only one notable instance does Barnet raise the question of personal as well as official disloyalty. He says that the Vietnam war makes an excellent case study of the relationship between a President and his principal advisers "because it was a conspicuous failure. At least one hundred bureaucratic accomplices in the tragedy have rushed into print with their own exculpatory versions of the story. One of them, John Roche, grandly declassified a secret memorandum written by Assistant Secretary of State Roger Hilsman in the pages of the *New York Times Magazine* [Jan. 24, 1971] the better to impeach the historical testimony of his bureaucratic rival, along with his character. Anyone interested in understanding the phenomenon of bureaucratic homicide can only welcome such public display."

This entire statement is an inexcusable performance by Barnet. While evincing nothing but praise for wholesale character assassination and other damage by Ellsberg and others (even the self-righteous Ellsberg expressed public concern), Barnet picks on John P. Roche, of all people. Roche was

in no sense a planner of the war but was Johnson's historian-in-residence or "intellectual." He replaced Kennedy's historian Arthur Schlesinger, who eulogized his boss rather clumsily, and Johnson's earlier historian Eric Goldman, who later was to write *The Tragedy of Lyndon Johnson*. Roche took no advantage of Johnson and still manages to explain the man better than anyone else.

Roche is a most readable and reasonable columnist for the Hearst newspapers, who might be called a reformed radical. This could explain Barnet's castigation of him, since no one infuriates a radical so much as a reformed radical. Roche wrote not to attack Hilsman's character but to set the

---

*"... no one infuriates a radical so much as a reformed radical."*

---

record straight. He handled the subject in the manner of a historian and not that of an "ideological warrior masquerading as a historian," such as were the "radical revisionist" historians who flourished for a while.

Barnet's lack of credibility in this and other instances tends to vitiate confidence in his judgments of the Kennedy-Johnson operators, yet this was a cast of characters he knew well, and his observations are generally in harmony with those of a number of others. Except for examples of exceptionally articulate analysis such as we have examined here, Barnet parallels David Halberstam's *The Best and the Brightest* and other works that hold up the Kennedy-Johnson briefcase warriors to gleeful ridicule. Once the record is set straight, these men should yet be examined with the understanding and compassion they themselves failed to demonstrate.

Nevertheless, remembering the pretentiously positive Bundy and the theatrically self-confident McNamara, who at his peak employed as speech writer a Ph.D. in philosophy to help him weep in words before he wept in person, one finds it difficult to resist Barnet's all too simple summary:

"Proclaiming that there is no alternative to peace in a world of atomic weapons, the national security managers waged a generation of 'brushfire' wars under the cover of a horrendous nuclear arms race . . . . Wringing their hands in public about the human failure represented by every bullet and tank produced, they poured money into the military and strained the civilian economy."

These brief sentences roughly represent a popular public view of the Kennedy-Johnson operators, and it is partly because of such statements that the public view is as it is. For this reason it is important to note that the statement, like Barnet's book and others, is heavily booby-trapped. The Vietnam failures led to loss of confidence in certain high officials, and this disillusionment has been extended by Barnet and others to include all governmental operations, past and future, the United States government itself, and, incredibly, all government, as we shall see.

AFTER each serious failure of a major governmental policy in foreign affairs, the participants divide into various groups. Some sell public confessions of error, while others defend themselves. Many remain tight-lipped, at least for a while, and of these some seek academic or organizational shelter until the storm subsides. Barnet comments on these shelters, two of which had already served during and after the unpopular Korean War: "A few former officials such as Paul Nitze in the 1950's and a number of Kennedy intellectuals in the 1960's took academic cover on leaving



office and helped during Republican administrations to convert such Washington institutions as the Johns Hopkins School for Advanced International Studies and the Brookings Institution into occasionally influential governments in exile." He does not mention certain crusading "foundations" nor the peculiar double role played by the Brookings Institution, which served as a crowded shelter for Kennedy partisans after Johnson took office. These dropouts and ejectees under Johnson were said by some to be the intended heirs of the voluminous secret study ordered by McNamara that became famous as "the Pentagon papers." In one explanation the papers, which none of the principal remaining operators with McNamara ever had time to read, were originally intended to be used, very selectively of course, in the Robert Kennedy Presidential campaign. When this was not to be, the more cynical and unstable of the exiles began dealing with remaining malcontents under McNamara and Rusk for secrets and even for documents. This process reached its climax when an ideologically oriented high official of the nonpolitical RAND Corporation, who has since been dismissed, was careless in trusting highly classified papers to his more radical friends, thus allowing Ellsberg to escape with the entire bundle.

Whatever truth there is in this obviously inadequate explanation must await further unraveling as the divisive radical crusaders continue telling on each other. *Roots of War* helps lay some of the groundwork for this process. Barnet describes the Kennedy policy of monitoring news stories. Lyndon Johnson, he says, devoted as much energy to members of the press, two of whom, Drew Pearson and William S. White, "wrote glowingly of his daily triumphs, but the President's continuing larger-than-life performance became less and less convincing against the background of an escalating war. Johnson

began to be in serious political trouble when the 'credibility gap' itself became news."

There is nothing new about the practice of cultivating friendly newsmen, and Kennedy could handle it reasonably well. The practice became unforgivable only when he started punishing uncooperative newsmen and applied the stick to publishers who spurned his carrots. Barnet says that he tried to get the *New York Times* to recall David Halberstam from Vietnam and that he called in a *Fortune* editor to rewrite with McGeorge's help an unfavorable article about Bundy.

Barnet overlooks another occasion when the President sent General Maxwell Taylor to persuade Henry Luce to discharge Charles Murphy as *Fortune's* Washington editor because of Murphy's detailed account of the mishandling in Washington of the Bay of Pigs invasion. Kennedy had canceled appointments with all Luce magazine reporters because one had written a story he did not like. Luce finally compromised by protecting his employees but cautioning them to write favorable stories. For this, struggling *Life* got exclusives on Jackie, White House redecorations, and such. One *Life* reporter who had previously written critically of McNamara commented after his later favorable story: "I didn't like it, but McNamara liked it so my boss liked it. We are welcome in the Pentagon again and that is important to me." Abraham Lincoln observed a hundred years earlier that such methods do not always work, especially in times of trouble, and time ran out on Lyndon Johnson after Kennedy had gone.

Neophytes in high government establishments have more trouble than newsmen in drawing the line between the public interest and their own or their boss's private interests. Yet most newsmen identify with the public interest well enough to become highly suspicious of officials who place it second. True, they tend to be prejudiced

in favor of those who give them usable stories, but they like to be convinced that those stories are serving the public interest and not just that of the official who released them. Barnet comments that the *Washington Post*, during the controversy over its use of the Ellsberg papers, complained that certain officials had made a practice of showing newsmen secret papers. In truth, McNamara regarded secrets as his personal property and used them for his own purposes so consistently that he banished from Washington certain other officials who were personally known by members of the press, and more than once he hired previously critical members of the press in an effort to make them personally loyal. It was this gradual erosion of the self-discipline of news media through their declining respect for leadership that opened the way for Ellsberg. Barnet reveals that Ellsberg had tried to peddle his papers to a major tv network a year before the *New York Times* accepted them.

Not all the "media, joint with under-the-

---

*"The Vietnam failures led to loss of confidence in certain high officials, and this disillusionment has been extended . . . to include all governmental operations, past and future, the United States government itself, and, incredibly, all government. . . ."*

---

dryer gossip," were willing to "process and vent without intermission all today's ugly secrets." A vast amount of restraint was shown, at some cost. Barnet, anxious as he is constantly to advance his rather mystical

ideology, was unwilling to go along with certain sensational but meaningless techniques: ". . . the television networks have never had an analysis in depth of the negotiating positions of the various sides of the Vietnam war. When I tried to bring up the subject on an NBC 'special' right after the Tet offensive of 1968, the producer kept passing me notes to say something juicy about the CIA in Laos. She was against the war, but she knew she would receive no plaudits for a serious, probably dull, discussion of the issues. The program would be counted a success only if it made 'hard news' in the Monday morning edition of the *New York Times*." Sometimes the pressures from all sides seem to converge, with the troubled as well as troubling media in the middle.

Again Barnet all but destroys the value of his perception by spreading his judgments back across history, which he little knows and less understands. In arguing that present difficulties arise from previous homicidal policies, ad infinitum, he charges Dean Acheson, whose stubborn honesty almost matched his brilliance, with practicing consistent deception.

To justify simplified statements of complex problems, Acheson wrote in his recently published memoirs that, since the average educated American spends probably less than ten minutes a day thinking about the world outside his country, "points to be understandable had to be clear. If we did make our points clearer than truth, we did not differ from most other educators and could hardly do otherwise." Barnet claims that Acheson's doing this in his descriptions of the Communist threat led to alarmism, to "right-wing backlash" and thence toward "preventive war," which Barnet calls "the prescription of the right wing." This, he says, is comparable to a famous remark of General Maxwell Taylor's which can be interpreted to mean that all a citizen should



be told about foreign policy is what he needs in order "to be a good citizen and to discharge his functions."

Do national security managers "find it necessary alternately to frighten, flatter, excite, or calm the American people"? Barnett says they do, and that "several planners say privately of the Vietnam War that their greatest miscalculation was excessive confidence in their ability to manage public opinion." He tries to relate Acheson's honest facing of the problem to the performance of Phil Goulding, McNamara's Assistant Secretary of Defense for Public Affairs, who "gives several examples of outright lies 'to protect the national interests' and several more of making events clearer than truth."

Since Goulding has turned anti state's evidence, Barnett has no quarrel with him, but he cannot resist an ironic comment. One of many such passages in Goulding's *Confirm or Deny* admits that he "told an untruth to the American people" and, he goes on, "Worse than that, I also misinformed some 235 million people of the second most powerful nation in the history of the world, the Union of Soviet Socialist Republics. . . . Misleading the puny-armed French . . . was one thing, but walking the Soviet Union down the garden path was another." Says Barnett: "His apology is interesting."

An ex post facto conscience, explained at book length, can become a thing of mystery. It might be that humor was Goulding's intent, but there is no humor for Barnett in international relations since nations themselves are all evil bureaucracies. Barnett explains at length how our national leaders, though practitioners of violence, are able to reassure each other that they are all honorable men. As with other "criminals," the fault is not their own but that of American society, which must be changed at once. Dean Rusk is exceptional in that he is seen by Barnett as once having displayed a conscience, which he quickly overcame. When

Rusk approved a stepped-up defoliation program in 1965 he was told it would damage only Viet Cong areas, and thus he found a way "to resolve inner moral doubts and to legitimize the ordering of a crime." The purpose of the "crime" was to make the leaves of trees fall.

A similarly Calvinist obsession with original American sin was displayed recently by

---

*". . . Barnett all but destroys the value of his perception by spreading his judgments back across history, which he little knows and less understands."*

---

one of Barnett's select "thinkers," William Appleman Williams, historian of the "American Empire" as well as its principal discoverer and explorer. Williams, who writes as though "American imperialism" were a single word, was asked to comment on a paper presented at the U.S. Air Force Academy by a Princeton University history professor. Williams's comments ignored the paper and instead called upon the cadets to refuse to discharge their responsibilities, in other words to mutiny, since the American ship of state was unfit to navigate, thus unwittingly providing an appropriate bit of humor that almost passed unnoticed.

Sigmund Freud is also listed as one of the thinkers most influential on *Roots of War*, though his theories are less in evidence than Williams's. Barnett is repeatedly scandalized by the fact that the national security managers somehow avoid guilt feelings (this despite Freud's contention that everyone should avoid them). Barnett writes bitterly: "The war planners . . . never betrayed a trace of remorse. Perhaps one can understand the pride that would keep them from

issuing public *mea culpas*. But it is hard to understand how some of them, upon hearing the revelations of the Pentagon papers, would address one another at cocktail parties with a breezy 'Hi, war criminal.' " Did Ellsberg "sacrifice" his obscurity in vain? The answer, of course, is no. Despite the breezily concealed embarrassment of victims exposed in mental undress, and despite certain baleful consequences, historians will benefit, provided they can get enough other documents declassified to achieve a balanced view.

One reason why Barnet and the Revisionist historians fail to make the objects of their preaching squirm in agony is lack of focus. True, their huge supply of under-the-xerox-dryer secrets gives them ample reason to condemn their erstwhile Pentagon associates. But "homicidal bureaucrats" and "bureaucratic killers" have dominated America since George Washington as they read, or tell, their country's history. Their treatment of various episodes, most of them shameful in their eyes, is surprisingly uniform, since a common lack of inspiration causes them to approach American history with a sophomoric sneer:

"For William McKinley, the Spanish-

American war was nothing less than a stern duty to 'uplift and civilize and Christianize' the Filipinos." This is one example of a technique closer to Goulding's methods than to Acheson's. Despite this and similar statements by Barnet, McKinley was forced into the Spanish-American War by public opinion in support of Cuban rebels, and any motivation to "uplift" the Filipinos arose after the Spanish-American struggle was over.

In another strained attack on a now historical figure, Barnet twice brands Lyndon Johnson as "racist" because once in telling a story he used the term "Mexican" in uncomplimentary context and he once used the term "yellow" in a manner that might be interpreted as applying to Orientals. He says that Johnson employed "homicidal technology" in Vietnam so that he would not have to "admit that he, the President of the United States, was as powerless to influence the dangerous outside world as he was to change America." These are false judgments of a U.S. President who changed the United States by achieving more important social and civil rights legislation than any other President.

San Antonio, Texas

*General Parrish's article will be continued in the next issue of the Review.*



The background of the cover is a dark, textured grey. On the left side, there is a white outline of the Soviet Union's geographical shape. At the top of this outline is a five-pointed star. On the right side of the map outline, there is a white fist with fingers curled, symbolizing dissent or protest. The text is positioned in the upper right quadrant of the cover.

# SOVIET DISSENT

*Its Sources  
and Significance*

MAJOR RALPH C. GAUER, USA

WESTERN military and political analysts interested in Communist systems continue to pay considerable attention to citizens' demands as evidence of satisfaction or dissatisfaction within the political system, "demands" meaning the citizens' expression that a value decision with respect to a given subject should, or should not, be made by those in authority.<sup>1</sup> This continuing analysis of citizen demands is now concentrating on the widely reported expansion of the Soviet "dissent movement."<sup>2</sup>

However, many current studies of the function of citizen demands in Communist systems seem to have a serious inherent weakness within themselves. As they focus on dissent, these studies acquire a negative quality, and at times they convey the unexpressed belief that the current Soviet political system is inherently less capable of response to valid citizen demands than is the democratic model. These studies likewise appear to assume that the domestic environment surrounding the democratic model is or should be equally valid and applicable to the Soviet political system.

Further, our traditional conception of a Communist state challenges the thought that citizens perform an important function in levying demands on Communist political systems. Lenin's assertion that the Communist party was and should remain the "vanguard of the proletariat" was a clear rejection of the idea that the masses should direct the party. Quite the opposite was to be true; the party, acting as the only repository of socialist truth, was the single-minded leader. Stalin is quoted as follows:

The party cannot be a real party if it limits itself to registering what the masses of the working class feel and think. . . . The party must stand at the head of the working class; it must see farther than the working class; it must lead the proletariat, and

not follow in the call of the spontaneous movement.<sup>3</sup>

Through the years, subsequent party leaders and documents have reasserted this basic theory. But there appears to be a significant gap between theory and practice.

#### Citizen Demands: Smolensk and After

The conflict between the theory of Communism and the realities of the day became evident to the non-Communist world with the publication of Merle Fainsod's *Smolensk under Soviet Rule*.<sup>4</sup> This work, based on documents captured by invading German forces in World War II and subsequently captured by U.S. forces, shed important new light on the workings of the Smolensk Oblast ("Province") Party (RSFSR). Fainsod demonstrated that citizens' demands served two vital functions: (1) they exposed and, therefore, inhibited misconduct at the lower administrative levels; and (2) they tended to diffuse popular discontent and direct that discontent from the center to specific local officials.<sup>5</sup>

While a second study of the magnitude of the Fainsod work is not possible because of a lack of data, other somewhat more oblique efforts by Milton C. Lodge<sup>6</sup> and James H. Oliver<sup>7</sup> continue to demonstrate the capacity of Communist systems to receive and process demands from a broader-than-party base.

Lodge's content analysis of selected periodicals concludes that five reasonably distinct categories of Soviet elites (members of party *apparatchiki* and the economic, military, legal, and literary communities) claim expanding roles in policy-making within their professions. Oliver's examination of lower administrative levels of the bureaucracy indicates that citizens continue to levy numerous demands upon the regime.



One might expand upon these efforts and assert that citizen demands also serve to identify systemic problem areas which require corrective action in sort of a management-by-exception method; expand the citizens' conscious or unconscious identification with the political system; co-opt the dissenter to the extent that he or she "participates" in the system; exercise the bureaucracy by forcing it to function; promote internal communication between and among various authorities and their agencies; and provide a continuing source of ideas, some of which will be incorporated into the goals of the polity.

If Fainsod, Lodge, Oliver, and others have demonstrated that the Soviet political system has the capacity to process some forms of citizens' demands, how is it possible that the system appears incapable of processing demands associated with the "dissent movement"? The answer to that question rests in the nature of citizen demand itself and the nature of the "dissent movement."

#### Some Characteristics of Demand

Whether voiced in a democratic, authoritarian, or other political model, citizen demands are multidimensional entities. Their multidimensionality includes an ideological component (conformity to a belief, or set of beliefs, which may or may not be verifiable but which are accepted as verified by the group because they perform social functions for that group), a material component (resources which would be set in motion toward the accomplishment of the goal or objective), a quantitative component (the numbers of politically relevant citizens voicing the demand), and finally, a previously established sum value component (the sum value of all other demands being voiced at that point in time). All political systems are required to assess and

evaluate these components as they receive and process total demand. As an equation, these components and total demand would appear as follows:

$$\left( \begin{array}{l} \text{ideological} \\ \text{component} \end{array} + \begin{array}{l} \text{material} \\ \text{component} \end{array} \right) \times$$

$$\left( \begin{array}{l} \text{quantitative} \\ \text{component} \end{array} + \begin{array}{l} \text{sum value of} \\ \text{other demands} \end{array} \right) = \begin{array}{l} \text{total} \\ \text{demand} \end{array}$$

All political systems are being tasked continuously to process total demand.

We can graphically illustrate both the ideological and material components of a single demand and total demand as well as a level of maximum possible demand. (Figure 1) Our purposes in doing so are threefold: First, in the cases of both single demand and total demand, such an illustration permits us to observe aspects of the *exchange* required in demand processing as the regime balances ideological and material considerations. This exchange may require some trade-off of the ideological component in favor of other components. This trade-off is not always singularly significant and may involve the sacrifice of what has been defined as "petty ideology";<sup>8</sup> however, it can be cumulatively significant. Second, in the case of total demand, such an illustration provides an indication of the *direction* in which the regime is moving as it processes total demand. Third, again in the case of total demand, such an illustration demonstrates the finite *limitations* that can exist with respect to the maximum demand processing capabilities of a regime.

It may appear from this graph that demand is static, but this is absolutely not the case. Demand is dynamic; the components are continuously subject to change and flux as citizens participate in their political system.

How does the Soviet "dissent movement" fit into this concept of demand? What are the ideological and material dimensions of

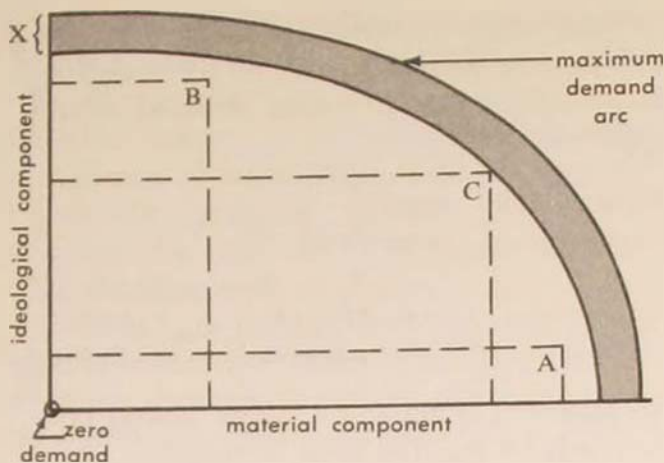

X - Maximum demand arc is not a specific point, but a broad threshold.

A, B, & C represent theoretical examples of trade-off between ideological and material components, based on total demand (sum of all demands being levied on a political system at any one point in time).

Figure 1. Selected dimensions of demand

the dissent demand? What is its quantitative component? Finally, how do the demands of the dissent movement impact upon the sum of other demands (total demand minus dissent demand) being levied upon the Soviet political system? To answer these questions, we must examine certain qualities of the Soviet "dissent movement."

### The Soviet Dissent Movement

There is no single "dissent movement" in the Soviet Union; there are dissent movements.<sup>9</sup> Western scholars and journalists have observed the resurgence of dissent in the Soviet Union since 1965 (the date of the Daniel-Siniavsky trials, frequently cited as a milestone in the post-Khrushchevian return to authoritarianism) and have attempted to specify its composition. Zev Katz, in his 1971 study of dissent,<sup>10</sup> categorizes participating elements as follows:

- the literary dissent movement, focusing on contemporary Soviet life and/or the injustices of current or former authorities. The best-known of the literary dissenters is Nobel Laureate Alexander Solzhenitsyn.

- the democratic (sometimes called scientific) dissent movement, focusing on human rights, the rule of law, and scientific free-

doms. The best-known of the democratic or scientific dissenters are Andrei Sakharov, Roy and Zhores Medvedev, and Andrei Amalrik.

- the religious dissent movement, focusing on religious freedoms and freedom from state interference in church-related matters. Elements exist within the Orthodox, Uniate, and Baptist churches and Jewish synagogues of the RFSFR, the Muslims of Central Asia, and among residual Catholicism in Lithuania.

- national minorities dissent movement, focusing on their ethnic identity and culture, on freedom for themselves and their lands from the U.S.S.R., or, alternatively, on the lessening of enforced Russification. This category encompasses Tatars, Turks, Kazaks, Ukrainians, Georgians, Lithuanians, Latvians, and Estonians, among others.

- the Great Russian nationalist movement, focusing on Russian (versus Soviet) traditions and culture and in some cases calling for a return to a "Slavophile"<sup>11</sup> attitude. This movement finds support in many areas of old Russia.

The dissent movements comprise a highly fragmented body of citizens whose views often coincide only to the extent that they are all in disagreement with the existing



authorities or regime. Significant differences exist not only among the five categories (for example, those favoring a return to Great Russian nationalism and those opposing Russification of ethnically different lands and peoples) but also within categories.

One of the principal modes of communication among the dissent movements in the Soviet Union is the *samizdat* (literally translated, "self-published") literature, a principal element of which is the continuing *Chronicle of Current Events (Khronika)*. The *samizdat* literature expresses a full range of citizens' demands, from the political left to the political right. Some authors condemn the existing order for being too lax and call for a return to Stalinism and the concentration camps. Others call for the spread of international Communism and/or international saber rattling. Still others issue demands for civil and social rights in the manner of social democrats and libertarians.

The *Chronicle* now serves as if it were a central journal of all movements of dissent. It provides information on arrests of members of all movements; it prints appeals and letters of protest in behalf of all types of dissent, as well as summaries of all journals and their views.

Recently, the overall impression of this literature has been somewhat similar to the press of a nontotalitarian country; the various journals represent widely different points of view and interests; they editorialize on each other, reprint items from each other, criticize and attack each other.<sup>12</sup>

Except for collective condemnation of the existing order, there appears to be little area on which virtually all *samizdat* authors agree.<sup>13</sup>

It may be concluded that we are dealing not only with a number of dissent movements but also with significant fragmentations within several of these movements.

Notwithstanding fragmentations, what are the total numbers of citizens (quantita-

tive component) participating in the dissent movements within the Soviet Union? One British observer of the Soviet scene reported in 1970 that ". . . dissidents probably comprise no more than one percent of the intelligentsia, and perhaps one half of one percent in other groups. And most of these are not against Communism or Socialism. They are more in nature of a loyal opposition. They want the system to work more efficiently and they want the Constitution to be observed."<sup>14</sup>

A more recent estimate shows from "several hundred" active dissents in the literary movement, to "thousands" active in the democratic, ethnic minorities and Great Russian nationalist movements, to "several score of thousands" active in the religious dissent movement.<sup>15</sup> At present there are approximately 250 million citizens in the U.S.S.R.

This fundamental weakness, an inability to achieve a wider base, has been recognized by members of the dissent movements themselves. Andrei Amalrik, in *Will the Soviet Union Survive until 1984?*, analyzed the 738 dissenters who had protested the Galanskov-Ginsburg trial and estimated the core of the movement to comprise no more than a few dozen active participants, these overwhelmingly intelligentsia, with only 40 workers (6 percent) and no peasants.<sup>16</sup> Thus another observer could report that, for all their cool determination, "Amalrik and his friends—and even Sakharov and his more influential colleagues—are nonentities to most Russians." The average Soviet citizen belongs to a "silent majority" of such awesome docility that, by comparison, the conventional American might almost be considered a Weatherman.<sup>17</sup>

This observation begins to blend with the impact of prior political norms and values on today's Soviet citizen and on his desire to levy certain types of citizen demands.

### The Soviet Union's Czarist Roots

It is impossible to understand the Soviet Union without examining the Russian ground on which it is built. It is also impossible to examine the conduct of the various dissent movements of 1973 without having an appreciation of the role of the individual citizen and prior authorities, for that is precisely the milieu in which that Soviet citizen perceives himself to be.

John Keep, commenting on Andrei Amalrik and the absence of any traditions that would suggest a citizenry capable of voicing Western-style participatory demand, states:

Amalrik is doubtlessly justified, however, in noting the limited social basis of the [literary and scientific] opposition, which is almost wholly an intelligentsia phenomenon. The broad masses of the Soviet population can only rise to "passive discontent . . . directed not against the regime as a whole but against particular features of it. They have no appreciation of freedom in the Western sense: [they] feel respect for force, authority, or even, ultimately, for intelligence or education, but that human personality of itself should represent any kind of value—this is a preposterous idea in the popular mind."<sup>18</sup>

George L. Yaney, in an article entitled "Law, Society, and the Domestic Regime in Russia, in Historical Perspective," corrects those who would even ask: Is the Soviet Union remaining totalitarian, or is it becoming "liberal"?<sup>19</sup> Yaney examines the ground on which the Soviet state is built, and he finds Russian soil. He advises his reader that because political freedom, as Americans use the term, is an attribute of a society, not an individual, and because individual rights repose in the *common recognition of them by the general citizenry*, such a question indicates a serious lack of understanding of Russian history from medieval times.

Yaney observes that, in Russia, neither freedom nor law has meanings based on

constitutional principles recognized by the citizen as legitimate. The "rule" of the czar was an abstraction; the rule of his agent was reality. Political power in the hands of such agents neither needed nor claimed support of the peasant. This historical fact gives birth to the present-day citizen's attitude toward his state: the Russian peasant views the state as being concerned with its own survival, against foreign and internal enemies.<sup>20</sup>

Liberalism in the Western sense has never been relevant in Russia.

Russian history impacts upon dissenters in still other ways. Even the best-known of the dissenters, Solzhenitsyn, cannot escape the fact that he walks in the paths of Dostoevski, Pushkin, Chekhov, and other Russian writers. Solzhenitsyn, the mathematician-turned-author, is compared with Dostoevski, the engineer-turned-author, with Pushkin, the civil-servant-turned-author, and with Chekhov, the medical-doctor-turned-author. Although they span the two greatest branches of Russian literature, the arts and the sciences, they continue to represent thoughts which the general populace may or may not *read* but upon which they generally will not *act*.

WHAT can be said in conclusion? What forecasts can be made with respect to the dissent movements and their political relevancy?

Andrei Amalrik's forecast is for an "inevitable" international war between the Soviet Union and China. He sees this war as providing the outside force that finally permits democratic change, which the Soviet citizen cannot achieve unassisted.<sup>21</sup>

A forecast of Sino-Soviet war for these reasons appears to be insufficiently founded, just as is a forecast of a successor Western-style democratic regime. On the one hand, it would appear rash to assume that the



Soviet regime will prove incapable of devising measures to moderate its dissenting citizens. On the other hand, we should not expect a successor regime to grow in other than Russian soil—now a somewhat Soviet soil.

As Soviet authorities continue to receive and process citizens' demands, they will continue to assess also the ideological, the material, and the quantitative components of these demands. They will be obligated continuously to make decisions with respect to trade-offs between and among these components. At times, the material or the quantitative components may suffer in favor of the ideological; but at other times, the ideological component must give way to other forces. Elements of the petty, and at times the grand, ideology must be sacrificed.

Referring to the concept of demand presented earlier, we can illustrate these exchanges and observe the direction in which the regime is moving. (Figure 2)

The ideological and material mix of demands levied by the ongoing dissent movements is clearly inconsistent with the sum of demands levied by the rest of society. The amounts of sacrifice required to meet

dissenters' demands fully may be more than regime authorities are prepared to *make*. But more important, dissenters' demands are greater than the general citizenry is prepared to *demand*. The general body of Soviet citizens is levying demands that move the system in a different direction.

Within the literary dissent movement, it is difficult to forecast when the pen may become as mighty as the sword. It is not the sword alone with which the pen must compete. Pens must compete with ballets and boxcars, toasters and telephones, pure science and puree. There is little to indicate that the way today's average Soviet citizen views the Soviet literary dissenter is significantly different from the way his Russian forebears viewed earlier Russian literary dissenters, or that the dissenter's message is more important than "proper" attention by the authorities to the average citizen's needs ("proper," that is, in *his* terms).

Within the democratic or scientific dissent movement, the conditions are somewhat different. There is less of a czarist tradition of *unscience*, and, as Zhores Medvedev carefully observed, when one is

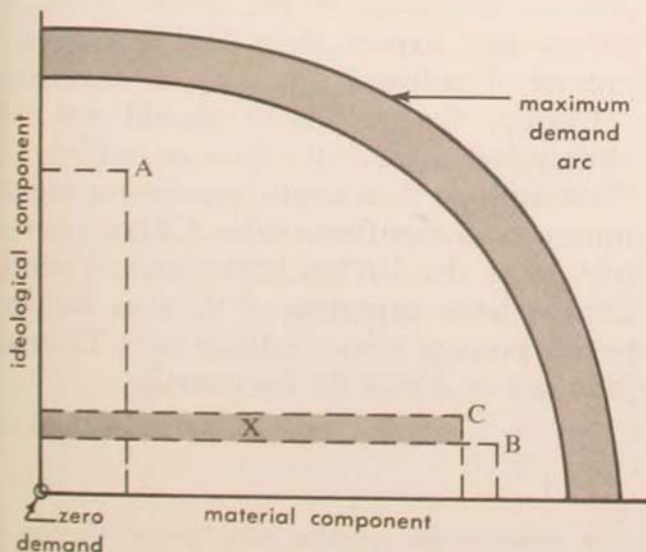

- A - value of dissent demands alone
- B - value of all demands minus dissent demand
- C - value of all demands (dissent and other)
- X - microimpact of dissent demands on total demand

Figure 2. Exchanges to meet demands

unscientific, progress (critical to U.S.S.R. development) is random or worse.<sup>22</sup> To restrict science as Lysenko did is to insure failure. This the Soviet scientist-dissenter opposes. To the extent that the scientist opposes unscientific conditions within his profession, Lodge and others indicate that his dissent and demands for alternative sets of conditions will increasingly be processed favorably. To the extent, however, that the scientist steps outside his discipline, he will be viewed by the regime's authorities as a member of a literary, religious, ethnic, or other dissent movement.

The Great Russian nationalist movement may now be in the process of being wholly or partly co-opted by the regime. Initially the movement began with younger Russians searching for their own past. However, the movement has been co-opted by both the Young Communist League (Komsomol) and other agencies of government.<sup>23</sup>

Herein is an example of the problems of trade-off between the ideological, material, and quantitative dimensions of demand. The Soviet Union is established in its ideology as a Marxist internationalist state, embracing all peoples and negating the need for any further search for meaning in life, whereas the title Slavophile would carry the state back to the ingrown, purely Russian nationalism of the past. Yet the regime felt it appropriate, in this case, to compromise on ideology in favor of validating linkages with the past.

Looking finally to the ethnic and religious minority dissent movements, we see that pre-Soviet czarist traditions do not apply. Lithuanians or Ukrainians should be expected to act more as Lithuanians or Ukrainians than as Russians or Soviets.

Citizens' demands viewed as invalid in the Russian tradition may be valid, indeed appropriate, within an ethnic or religious minority. This would seem to be the fundamental reason for the Soviet Union's intensification of national unity programs and for the regime's dealing most severely with ethnic and religious dissent.

Amalrik saw the credibility of ethnic dissent when he forecast the creation of several ethnically homogeneous states from the ashes of the Soviet Union.<sup>24</sup>

Several final observations are possible:

First, the Soviet dissent movements are not politically significant in any macro change sense. These movements are not observable tips of icebergs that continually threaten the Soviet ship of state. In a micro sense, the dissent movements carve out expanded new areas of political pluralism, at the same time strengthening older areas.

Second, a statement that Soviet citizens do not meaningfully participate in their political system is misleading. One must ask, meaningful to whom? Studies from Smolensk forward demonstrate that Soviet citizens *do* participate but that this participation is limited not only by what the regime views as permissible but by what the citizen views as appropriate. Military and political observers of the Soviet political system can expect this slow but steady process of political pluralism to continue.

Finally, Soviet dissent should not be interpreted outside its Russian milieu. A Western-style democratic movement is not imminent or even foreseeable. Citizen participation as the United States and Western Europe have experienced it is as foreign to the average Soviet citizen as is Thomas Jefferson or Alexis de Tocqueville.

Fort Bragg, North Carolina

#### Notes

1. For a detailed examination of the function of demand, see David Easton, *A Systems Analysis of Political Life* (New York: Wiley, 1965), especially Part Two.

2. As examples, see Peter J. Potichnyj, editor, *Papers and Proceedings of the McMaster Conference on Dissent in the Soviet Union* (Hamilton, Ontario: 1972); Zev Katz, *Soviet Dissenters and Social Structure in the USSR* (Center



for International Studies, Massachusetts Institute of Technology, Cambridge, Massachusetts, 1971); Abraham Brumberg, editor, *In Quest of Justice: Protest and Dissent in the Soviet Union Today* (New York: 1970); and Max Hayward and William C. Fletcher, editors, *Religion and the Soviet State: A Dilemma of Power* (London: 1969). For Soviet, or Russian, points of view, see Andrei Amalrik, *Will the Soviet Union Survive until 1984?* (New York: 1970); Andrei Amalrik, *Involuntary Journey to Siberia* (New York: 1970); Zhores Medvedev, *The Rise and Fall of T. D. Lysenko* (New York: 1968); Roy and Zhores Medvedev, *A Question of Madness* (New York: 1971); Andrei D. Sakharov, *Progress, Coexistence, and Intellectual Freedom* (New York: 1968); Alexander Solzhenitsyn, *One Day in the Life of Ivan Denisovich* (New York: 1969); and Alexander Solzhenitsyn, *First Circle* (New York: 1968).

3. Quoted in Merle Fainsod, *How Russia Is Ruled* (Cambridge: Harvard University Press, 1963), p. 137.

4. Merle Fainsod, *Smolensk under Soviet Rule* (New York: Vintage Books, 1963).

5. *Ibid.*, Chap. XX.

6. Milton C. Lodge, *Soviet Elite Attitudes since Stalin* (Columbus, Ohio: Charles E. Merrill Co., 1969).

7. James H. Oliver, "Citizen Demands and the Soviet Political System," *American Political Science Review*, June 1969.

8. D. Jarovsky, "Soviet Ideology," *Soviet Studies*, July 1969, pp. 3-20.

9. See Lewis S. Feuer, "Intelligentsia in Opposition," *Problems of Communism*, XIX, 6 (November-December 1970), 1-16; John Keep, "Andrei Amalrik and 1984," *The Russian Review*, XXX, 4 (October 1971), 335-45; Bohdan R. Bociurkiw, "The Voices of Dissent and the Visions of Gloom," *The Russian Review*, XXIX, 3 (July-August 1971), 328-35; and Katz, *op. cit.*

10. Katz, pp. 2-29.

11. Slavophile: During the reign of Czar Nicholas I (1825-1855), a Slavophile movement arose around Moscow University. This movement revolted against

French and British influence in Russia, asserting that Russian civilization was fundamentally superior to Western European civilizations, which the Russian educational community was then courting. This conflict between Western European and Russian traditions continues near the heart of several of the ongoing dissent movements.

12. Katz, pp. 26-27.

13. One possible exception can be seen in *samizdat* handling of the People's Republic of China. There are no reported pro-PRC commentaries appearing in *samizdat* literature, possibly demonstrating an unwillingness to go outside the party on intraparty matters, or in reaction to 300 years of Tatar rule.

14. *U.S. News and World Report*, LXIX, 44, 30 November 1970.

15. Katz, p. 26.

16. Amalrik, *Will the Soviet Union Survive until 1984?* pp. 76-77.

17. *Newsweek*, 1 February 1971, p. 33. Solzhenitsyn may be an exception, to the extent that his works are apparently widely read, and the effect of both Radio Liberty and Radio Free Europe in publicizing Solzhenitsyn within his own country has been great. However, the political effect of Solzhenitsyn is subject to serious question.

18. John Keep, "Andrei Amalrik and 1984," *The Russian Review*, XXX, 4 (October 1971), 341.

19. George L. Yaney, "Law, Society, and the Domestic Regime in Russia, in Historical Perspective," *American Political Science Review*, June 1965, pp. 379-90.

20. *Ibid.*, pp. 386-87.

21. Amalrik, *Will the Soviet Union Survive until 1984?*

22. Medvedev, *The Rise and Fall of T. D. Lysenko*.

23. Georgia Anne Geyer, "A New Quest for the Old Russia," *Saturday Review*, 25 December 1971, p. 16.

24. Amalrik, *Will the Soviet Union Survive until 1984?*



# Military Affairs Abroad

## PHASES OF SUBVERSION

*The Castro Drive on Latin America*

JAY MALLIN

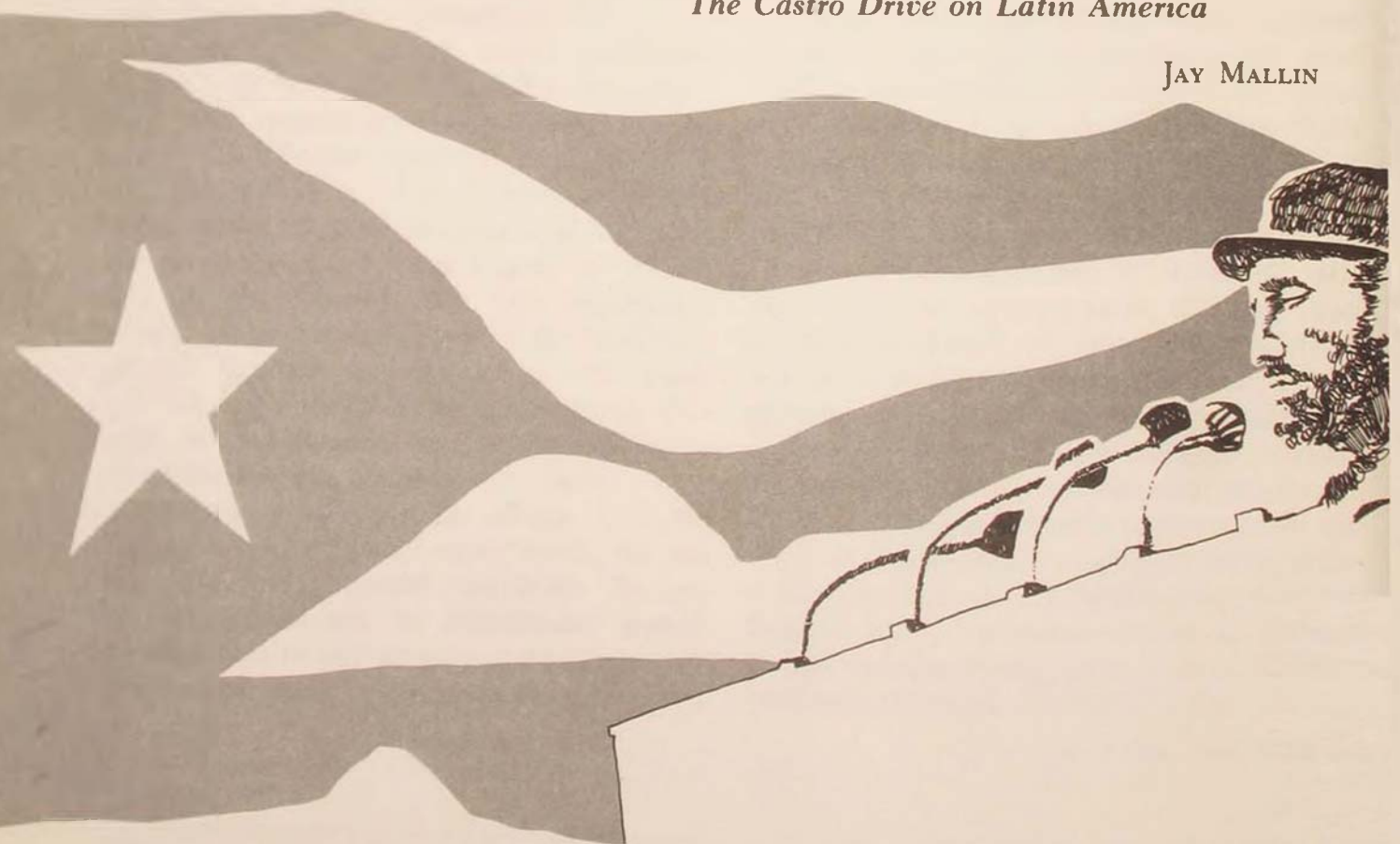



**F**EW COUNTRIES in the world in recent history have carried out programs of subversion with the consistency and determination of Communist Cuba under Fidel Castro. Subversion, directed especially against other Latin American countries but also reaching as far away as Africa and even into the United States itself, has been a primary policy of the present Cuban government almost from the day it came into power.

Less than a month after the revolutionary movement took control in Cuba early in 1959, Ernesto "Che" Guevara declared, "The Revolution is not limited to the Cuban nation."<sup>1</sup> And in March 1959 Fidel Castro stated, "The Caribbean is ours."<sup>2</sup> In July 1960 Castro bluntly declared, "We promise to continue making [Cuba] the example that can convert the Cordillera of the Andes into the Sierra Maestra of the American continent."<sup>3</sup> This was not mere rhetoric; the Castro regime matched actions to words. Exiles of diverse nationalities and political stripes flocked into Cuba following the rebel victory, and those deemed to be ideologically acceptable—especially by Guevara, the government's in-house international expert—received moral support and military assistance in the form of training and equipment.

The first Cuban aggressive effort was directed against Panama. In an amateurish and near-comical venture 84 expeditionaries, 82 of whom were Cuban, landed at Nombre de Dios, an almost inaccessible village on the Caribbean coast of Panama. The invaders had to be "rescued" by the Panamanian National Guard, which utilized a landing barge borrowed from U.S. authorities in the Canal Zone. After a brief

stay in a Panamanian jail, the invaders were sent back to Cuba with a stern warning. One Cuban stayed behind; he decided to marry a Panamanian girl he had met at Nombre de Dios.

Cuba was not deterred by this fiasco. In June 1959, coordinated air and sea landings of expeditionaries, armed in and launched from Cuba, took place in the Dominican Republic. All but a few of the invaders were killed by Dominican forces. In August 1959 another invasion group infiltrated Haiti from Cuba, and it, too, was wiped out. In Nicaragua also an insurgency, which had received an arms shipment by plane from Cuba, was quelled.

These four attempts to establish guerrilla operations in Caribbean-area countries having failed, the Cuban government developed more sophisticated subversive techniques. No more filibustering expeditions would be launched from Cuba. Instead other tactics were employed: Cuban diplomats provided financial aid to pro-Castro groups in the Latin American countries. Cuban fishing boats slipped weapons ashore to be used by insurgent movements. Propaganda was beamed from powerful Cuban shortwave stations, circulated through Cuban diplomatic missions, and distributed by the *Prensa Latina* news service. (*Prensa Latina* was organized by Jorge Ricardo Masetti, an Argentine friend of Guevara's who would die a few years later leading a Castroite guerrilla movement in Argentina.)

The greatest emphasis, however, was on the instruction of Latin Americans in guerrilla warfare. To this end, hundreds, and then thousands, of men were brought to Cuba, trained in special schools and camps,

and returned to their homelands to start insurgencies or join campaigns already under way. Venezuela, Colombia, and Guatemala were among the nations most seriously affected by Cuba-assisted guerrillas; however, few countries in Central and South America escaped at least minor outbreaks.

Guerrilla courses in Cuba lasted from three to six months and occasionally as long as a year. Manuel Celestino Marcano Carrasquel, a Venezuelan who received the training, later described it to an investigative committee of the Organization of American States. He reported:

I took courses in guerrilla and counter-guerrilla tactics, theory and practice; assembling and disassembling short and long weapons, especially some of the ones that were easiest to acquire. . . . In explosives I was given a course that covered home-made bombs using chlorate, grenades, booby traps, "Molotov cocktails" of various kinds. . . . They put a great deal of emphasis on blowing up pipelines. . . . I took a course in mapmaking and mapreading, including reading of tactical maps. . . .<sup>4</sup>

The first Cuban efforts at subversion in 1959 appear to have resulted from a combination of factors: the exuberance of the revolutionaries after their victory against a regime considered to be militarily superior; a belief on their part that it was up to them to set right what was wrong in other countries; a desire by Castro to become, as signs in Havana proclaimed, *El líder de las Américas*; and the eagerness of Guevara to export Marxist revolution. As Cuba moved toward Communism and became alienated from the rest of Latin America, the support of insurgency developed into an integral part of Cuban foreign policy. It was a policy which aimed at the communization of other countries, but it had practical as well as ideological motivations. Cuba needed allies that could provide it with support

and break its hemispheric isolation. Venezuela was a particular target of Cuban subversion because of its vast oil reserves. Obtaining access to these would have made Cuba less reliant on the Soviet Union, Cuba's sole provider of vitally needed petroleum. Blas Roca, a leading Cuban Communist, stated in 1963:

If their [Venezuelan] struggle is a help to us today, their victory will give us an even more tremendous help. Then we shall no longer be a solitary island in the Caribbean confronting the Yankee imperialists, but rather we shall have a land of support on the mainland.<sup>5</sup>

Because of its geographical proximity, the Dominican Republic was another priority target for Cuba's insurgency program. First came the abortive June 1959 expeditions. Then, in November 1963, another guerrilla operation was launched with full Cuban support. Cuba had trained a number of the guerrillas who participated and attempted to send them a shipload of weapons; these were intercepted by Dominican forces. This guerrilla movement also was defeated. In 1965 an unexpected opportunity for Cuban subversion occurred. Late in April of that year the government of Dominican President Donald Reid Cabral was overthrown as the result of a military uprising. No clear-cut change of authority took place, however, and the situation in the capital city deteriorated rapidly. Mobs swirled through the streets, stores were looted, policemen were killed.

Rebel elements, including some army troops, controlled the downtown area of Santo Domingo. The air force, which had its own tank and troop units, held the big San Isidro air base across the Ozama River. Air attacks were carried out against the rebels, but the air force's troops were unable to force their way across the Duarte bridge and into the insurgent stronghold. Within the city, foreign embassies were



fired upon, the Guatemalan ambassador was threatened by a mob, and U.S. diplomatic personnel gathered Americans and other foreigners at the Embajador hotel in preparation for evacuation.

There were three Communist parties in the Dominican Republic, including the Castro-aligned *Agrupación Política Catorce de Junio*, named for the date of the 1959 expeditions. The chaotic situation in Santo Domingo was made to order for the Communists, particularly those who had received training in subversive techniques in Cuba. They armed themselves and assumed control of the street crowds. Several thousand weapons were trucked in from a rebel army camp and distributed among civilians.

The Communists helped organize paramilitary units and set up strongpoints at strategic locations. Directing the Communist military activities was Manuel González González, a veteran of the Spanish Civil War who was believed to be an agent of Cuba's intelligence service. Approximately a thousand troops of the regular army had participated in the revolt. The Communists hurriedly armed themselves and other civilians whom they controlled, and these paramilitary forces soon outnumbered the troops. As a result of this burgeoning power, the Communists within a few days were generally dominating the rebel leadership. (Titular leader of the revolt was an army colonel named Francisco Alberto Caamaño Deñó.) The United States, supported by the Organization of American States, intervened militarily in the conflict, probably preventing what might have become a Communist take-over of the entire country.

The Dominican uprising was an aberration—a move by military men which degenerated into near-chaos and a resulting opportunity for the Communist movement. Other countries suffered Cuba-directed or -assisted insurgencies, but in these coun-

tries, too, the subversive efforts failed to achieve their objectives, the establishment of pro-Castro Communist regimes. The Latin America of the sixties was not Cuba of the fifties, where the army of strongman Fulgencio Batista was unable to cope with the guerrilla movement. Farsighted Latin American governments were undertaking significant social programs. Armies, acutely aware of the danger inherent in guerrilla movements, moved with determination to wipe these out whenever they appeared. The United States, on its part, developed counterinsurgency concepts, including civic action, and instituted effective means of teaching these to the Latin American military.<sup>6</sup>

Castro, however, was not discouraged. His regime was, in fact, prepared to make an attempt to institutionalize subversion. What could only be termed an international conference to foment subversion was held in Havana from 3 to 15 January 1966. Officially, it was called the "First Conference of Solidarity of the Peoples of Africa, Asia, and Latin America," but for brevity's sake it came to be known as the "Tricontinental Conference." From 82 countries came over 600 representatives, chosen by local Communist parties and "liberation movements." The tone and purpose of the conference were indicated by the agenda, which included such phrases as "Struggle against imperialism . . . Struggle for complete national liberation . . . Intensification of all forms of struggle . . . Ways and means of aiding the liberation movements in Africa, Asia, and Latin America . . . Burning issues of the struggle."<sup>7</sup> The Tricontinental adopted 73 resolutions aimed at "the system of imperialist, colonialist, and neo-colonialist exploitation against which it has declared a struggle to the death."<sup>8</sup> Castro told the delegates that the conference had been "a great victory of the revolutionary movement."<sup>9</sup>



### The Bolivian Expedition

*After Castro came to power in Cuba in 1959, he followed a policy of actively attempting the subversion of other Latin American countries to his brand of Communism. The series of attempts to instigate Marxist revolution met with failure, a final conspicuous instance taking place in Bolivia in 1967. There Castro's lieutenant, "Che" Guevara, and a small band of guerrillas met with insuperable difficulties in their attempt to spread insurgency from their mountain bases. In these rare photographs of them, Guevara directs and observes the operations, and the group is seen awaiting a meager mess (Che is fourth from the right).*







The holding of the Tricontinental conference graphically demonstrated that Castro's subversive interests extended beyond Latin America. In the Guevara-Castro view, undeveloped nations were particularly susceptible to Communist take-overs via guerrilla movements. Acting in accordance with this concept, Cuba has given a full measure of attention to Africa. As early as 1961 a Zanzibar National party office, headed by a former Mau Mau, John Okello, was opened in Havana. By mid-1962 men from at least nine African countries, including Zanzibar, were receiving subversive training in Cuba. In January 1964 a rebel movement in Zanzibar led by Okello overthrew the pro-Western government and set up the "People's Republic of Zanzibar." Cuba has also been involved in the Congo (Brazzaville), where Cuban troops help maintain the leftist government in power, and in Portuguese Guinea, where Cubans serve with the guerrilla forces (eight Cubans were reported killed early in 1973 when they were intercepted trying to infiltrate the colony).

The United States hardly qualifies as an undeveloped country, but even here Castro's agents have been active. In November 1962 the FBI arrested three Cubans in New York, including an attaché of Cuba's United Nations mission, and charged them with planning to place bombs in stores, oil refineries, and the New York subway system. A cache of explosives and incendiary devices was seized. In 1968 two other Cuban representatives at the U.N. were barred from the United States because they had been providing guidance and financial assistance to American black extremist groups.

Through the first half of the sixties Guevara masterminded Cuba's operations abroad. Then, apparently tiring of the successive failures in Latin America, he decided to go into the field himself once

more. He chose Africa as his new battleground, feeling that this continent was comparatively far from the United States' sphere of power and influence and close to Communist and other sympathetic countries. Leading a group of Cubans, Guevara involved himself in the struggles in the Congo.

The African adventure also failed—Guevara was evidently there six months—so Guevara returned secretly to Cuba, where he began preparations for yet another guerrilla movement. This one would be in Bolivia, where he believed the government of President René Barrientos could be overthrown much as that of Cuba's Fulgencio Batista had been brought down in 1959. Furthermore, Bolivia was centrally and strategically located so that, in Guevara's view, it could serve as a base for spin-off operations in adjoining countries, especially Argentina.

A high-level military group was organized and trained in Cuba and then infiltrated into Bolivia. There a farm had been purchased in an isolated area near the town of Camiri, and this was to serve as the base camp for the guerrilla operation. Guevara, in disguise and using two Uruguayan passports, traveled to Bolivia via Spain and Brazil. On or around 7 November 1966 he arrived at the base camp, and the insurgency was under way. An indication of the importance given to it by Cuba was the presence with Guevara of sixteen Cuban military men, including three *comandantes* (highest rank in the Cuban army) and six captains. Three of the officers, in addition to Guevara, had been members of the Central committee of the Cuban Communist party.

On 23 March 1967 the guerrillas staged their first attack. They ambushed a Bolivian army patrol, killing seven soldiers and taking eighteen prisoners. Other guerrilla actions in the following months were simi-



arly successful, but eventually the tide turned against Guevara's group. The peasants of the region did not provide the support Guevara expected and needed (Bolivia had had an extensive agrarian reform in 1952, and Guevara had little to offer). A clandestine apparatus in the cities which might have supported the guerrillas was broken up by the Bolivian authorities. Even the local Communist parties, refusing to accept leadership from Guevara, a foreigner, failed to provide assistance. The Bolivian army encircled the area in which the guerrillas operated and effectively isolated them. The United States, rather than permit itself to be sucked into a potential Vietnam-like situation, did not send combat troops but, instead, gave four months of training to a Bolivian Ranger battalion. It was this unit that eventually tracked down Guevara and the remnants of his band. Guevara was captured 8 October 1967, and the next day he was executed.

The climactic phase of the eight-year Cuban insurgency program had terminated in total defeat. The full extent of the Cuban operation was revealed later when Orlando Castro Hidalgo, a defector from the Cuban intelligence service, disclosed that at approximately the time Guevara was preparing to go to Bolivia, two *comandantes* of the Cuban army, both of them members of the Cuban Communist party's Central committee, were infiltrated into Venezuela to assist guerrillas in that country.<sup>12</sup> Guevara's movement in Bolivia had been part of a two-pronged attack on South America. The Venezuelan effort, like the one in Bolivia, ended in failure (although, unlike Guevara, the two *comandantes* in Venezuela eventually got back to Cuba).

CASTRO, aided by Guevara, Raúl Castro, and other able lieu-

tenants, had led a guerrilla movement which was part of the revolution against Batista. The movement was a major factor in Batista's eventual overthrow, but it was not the only factor: effective operations by urban clandestine organizations, a substantial decline in the Cuban economy, and the United States' cutoff of arms and support for Batista also contributed to his fall. Upon coming to power, however, Castro and Guevara overlooked these other factors, preferring to emphasize the guerrilla role in the revolution. Out of this grew a mystique of guerrilla invincibility, a mystique in which Castro and Guevara really believed (so much so that Guevara staked his life on it, and lost). It was this mystique that was the conceptual foundation for much of Cuba's subversive effort during the sixties. Start a guerrilla movement, support it, and it will eventually succeed—thus thought the planners in Havana. But not one such guerrilla operation in Latin America succeeded, and with the death of Guevara and the failure of the grand plan (Bolivia-Venezuela), Havana was forced to accept the fact that other methods were needed.

Cuban subversion entered a new phase. There would be more sophistication and selectivity in the program. Substantial numbers of men would no longer be sent abroad to start guerrilla operations.<sup>13</sup> Funds, weapons, and trained agents would still be sent to existing movements, but not on the scale of previous efforts.

A doctrinal shift also occurred. In a speech on 13 March 1967 Castro faulted Venezuelan revolutionaries because in their strategy there had been "an over-estimation of the importance of the capital and of the struggle in the capital and an under-estimation of the importance of the guerrilla movement."<sup>14</sup> The death of Guevara was a severe blow to the guerrilla mystique, and now Cuba reluctantly turned its attention to the cities of Latin America as

a potentially fruitful battleground. A case in point was Montevideo, Uruguay, where the Tupamaro clandestine organization was growing in strength, boldness, and operational capability. A number of Tupamaros were trained in Cuba; an interrogation manual used by the Tupamaros was written in Cuba or by a Cuban. The Uruguayan army's intelligence department learned that Castro, during a trip through Africa, met with a Tupamaro representative and gave him \$265,000 in cash to support the insurgent movement.

The Tupamaro movement was crushed by the Uruguayan army in 1972. Castro, however, seems intent on continuing to use urban terrorism as a major method of subversion. In February 1973 a U.S. State Department official reported that "several

hundred" persons in Cuba were being trained in urban terror tactics.<sup>15</sup>

Castro's persistence in pursuing a policy of subversion has a direct bearing on relations between Cuba and the United States. These relations were broken in January 1961, and American officials have repeatedly stated that they will not be resumed until Castro, among other things, ceases trying to subvert Latin American countries. Castro, however, has indicated no interest in doing this. He stated bluntly in 1971: "Cuba maintains its policy of support to the revolutionary governments and also support of the revolutionary movements of Latin America."<sup>16</sup> Subversion continues to be an operational policy of the Cuban government.

Coral Gables, Florida

#### Notes

1. Ernesto Guevara, "Proyecciones Sociales del Ejército Rebelde," *Ernesto Che Guevara, Obras 1957-1967* (Havana: 1970), Vol. 2, page 21.
2. "Fastest Gun in Havana," *Time*, 23 March 1959.
3. James Monahan and Kenneth O. Gilmore, *The Great Deception* (New York: 1963), p. 153.
4. *Report of Committee 1 of the Twelfth Meeting of Consultation of Ministers of Foreign Affairs*, Organization of American States (Washington: 1967), p. 74.
5. Jay Mallin, *Fortress Cuba* (Chicago: 1965), p. 73.
6. Willard F. Barber and G. Neale Ronning, *Internal Security and Military Power* (Columbus, Ohio: 1966).
7. Orlando Castro Hidalgo, *Spy for Fidel* (Miami: 1971), p. 96.
8. *Cuba Socialista*, Havana, February 1966, p. 101.
9. *Ibid.*, p. 79.
10. *Ibid.*, p. 149.

11. "Declaración General de la Primera Conferencia Latinoamericana de Solidaridad," *Teoría y Práctica*, Havana, August 1967.

12. Castro Hidalgo, p. 48.

13. In special cases Castro seems still willing to try to set up new guerrilla operations. After the termination of the 1965 Dominican uprising rebel chief Caamaño went to London as Dominican military attaché. In October 1967 he took a trip to The Hague, where he disappeared from public sight. He went to Paris in disguise and from there was spirited by the Cuban intelligence service to Cuba via Prague. Evidently Castro wanted to use him in the Dominican Republic again one day. Early in February 1973 Caamaño did land on the Dominican coast with a small group of armed men. Pursued by Dominican forces, he was killed in battle a fortnight later.

14. Speech transcribed by the Latin American Monitoring Service.

15. "'Urban Terror' Experts Reported Cuba-Trained," *Miami Herald*, 21 February 1973.

16. Foreign Broadcast Information Service, 20 April 1971.





## Air Force Review

### THE CHANGING SCENE IN EDUCATION

MAJOR CHARLES W. MITCHELL

*There will always be a frontier where there is an open mind and a willing hand.*

—CHARLES F. KETTERING

*The instructor was perplexed:*

*New class—what now? . . . First exam shows distributed ignorance from 20% to 70%—average 50%—standard deviation 10%—A to C. . . . Can't give an F since student failure is seen as teacher failure. . . . Question in review session—repeatedly stressed the answer in lectures since the second day. . . . Why don't they learn? . . . What's this? An article saying that in a lecture only 12% listen?<sup>1</sup> I don't believe it!—must be an invalid experiment—Jones said he understood nothing from prerequisite*

*course—need lectures to compensate for bungling of others. . . . Wait! Here's an article on course design—make learning constant and time variable<sup>2</sup>—Ridiculous!—might find that we have only a two-year school. . . . Who left this book on my desk?—Conditions of Learning by Gagne<sup>3</sup>—learning theory—more unscientific bunk! I'm teaching science, not psychology. . . . Instructional objectives?—something about a book by Mager<sup>4</sup>—Why? My objectives are obvious from my lectures and exams—multiple testing on same material?—naïve. Everyone would get an A! . . . so what if all of my students are above average? . . . Someone has to get the low grades—After all, there's the curve. . . . Individualize? Maybe that's the magic word. It certainly is popular these days—But how?—can't teach everything to everyone individually—How can they learn if I don't teach them?—self-study?—reading?—self-pacing?—individually guided practice?—behavioral objectives?—What will they think of next?*

THIS hypothetical mental monologue reflects some of the traditional views that continue to plague the educational system and professional educators, especially at the higher levels. In an attempt to overcome some of these traditional educational barriers, an experimental self-pacing program was introduced in the Department of Electrical Engineering at the United States Air Force Academy. It is felt that the findings of the program show potential for application beyond the Academy and even beyond the college level of instruction.

BEFORE launching into the annotated case history, some perspective may be worth pursuing. Traditionally, instruction has been “teacher-centered”; that is, emphasis has been placed upon teacher rather than learner efficiency. It has been argued that the traditional instructor is likely to view society and education as static and authoritarian, the student as passive and receptive, the learning process as associative and additive, and the teacher as tasksetter and drillmaster. In contrast, a modern instructor is characterized as “learner-centered”; he will tend to assign more importance to the problems of learning

than to the problems of teaching. A learner-centered instructor is thought to view society and education as dynamic and democratic, the student as a behaving and active participant in his own education, the learning process as interactive experience, and the teacher as a participating guide in the learning process.<sup>5</sup> Obvious shades of gray exist between these extremes. It would be foolish to say that educators who tend to be traditional have no concern for learning. The distinction seems to lie in what they do about failure to learn. The traditional thinker tends to favor the lecture method and curve grading. He will therefore look to himself to improve the lecture, which he presumes will improve learning, and adjust the grading curve accordingly. The modern thinker may recall such words as “. . . The lecture is dead! Investigations show that information communicated verbally without involvement has a short retention span; students who attend lectures perform no better than students who do not; lecture classes fail because students are in a passive, nonparticipating role; and lectures in courses requiring higher cognitive skills are notably less effective.”<sup>6</sup> The modern instructor will therefore seek improvement in the form of methods that demand interaction



on the part of the learner. His preferred choice is not likely to be an improved lecture. In his deliberations he may also recall one of the professional educator's clichés: "I hear, and I forget; I see, and I remember; I do, and I understand."

In the spring of 1971 the Department of Electrical Engineering at the Air Force Academy decided to test the claims of a growing number of educational innovators who advocate a learner-centered system of instruction called "self-pacing."<sup>7</sup> The method seemed to be a natural for a course on which much preliminary effort had been expended with only modest success. The basic problem, which persisted in spite of extensive attention, was that the core curriculum in electrical engineering continued to be viewed as demotivating or unreasonably difficult by the students and inefficient by both instructors and students. To understand the background for the decision to "self-pace" the course, it is necessary to review about five years of its development.

In 1966 one of the more serious departmental problems was what constituted appropriate content for the course. An effort was initiated then to develop the textbook that has emerged, after extensive and continuing revision, as the course content standard.<sup>8</sup> In addition to prescribing course content, the text includes a three-level hierarchy of student activities at the end of each chapter: elementary "questions" (level 1), intermediate "exercises" (level 2), and relatively advanced "problems" (level 3). These activities suggest levels of achievement and, by implication, define behavioral objectives. Another problem existing in 1966 was an ineffective laboratory program. The traditional two-hour laboratory was eliminated from the electrical engineering core curriculum; the lock-step inflexibility of the lab program had proven to be demotivating. Instead,

basic electronics equipment was placed in the existing 16-man classrooms (one setup for every two students); the result was a combined classroom-laboratory in which elementary laboratory activity was integrated into the theoretical discussions of the classroom. Instruction was planned so as to include use of the electronic equipment when it seemed pedagogically desirable.<sup>9</sup> Thus, both a standard text and an integrated classroom-laboratory existed as initial conditions on the problem-solving process leading to the self-paced course. During the summer of 1971 the course was cast in the self-paced format and offered during the following semester. Because it was a first at the Air Force Academy, the course was dubbed "experimental."

The course was divided into eleven units. Unit study guides were developed to direct the student efficiently to whatever level he chose (three possible levels, corresponding to the three levels of practice items outlined in the textbook). The essential contents of each study guide were the reading assignment, behavioral objectives for each of the three levels of achievement, suggested practice activities related to each behavioral objective, and appropriate self-demonstrations (equipment exercises). Guidelines for developing the behavioral objectives must be credited to R. F. Mager and R. B. Waina.<sup>10</sup> Mager prescribes the basic content of behavioral objectives in an instructional setting, and Waina expands on the measurability of objectives, especially as it is affected by choice of verb. Waina also suggests a procedure for writing objectives in the form of "definitive problems," i.e., required or suggested student activities in which specific objectives are embedded. Practice activities were specified by outlining a hierarchy of interrelationships among the various concepts and student activities involved and arranging them in an orderly fashion. Such

learning structures obviously involve many trade-offs and overlaps and are therefore likely to be time-consuming and imprecise; however, the results were encouraging. The third element of each unit study guide was an appropriate set of self-demonstrations, or minilabs. These were the guidelines by which the contiguity of presentation of theoretical and practical concepts was assured. Their number depended upon the subject matter; the average time required for completion of each was 20 to 30 minutes.

Of the many ways to individualize instruction, self-pacing is among the more straightforward. Dr. Fred S. Keller, generally acknowledged as the originator of the method, identifies five features that seem to distinguish it most clearly from traditional teaching methods.<sup>11</sup> (In the following subparagraphs, the italicized sentence summarizes Keller's basic feature; the remaining comments indicate alterations that were made for the experimental electrical engineering course and the constraints that prompted them.)

- *Go-at-your-own-pace; the student moves through the course at a speed commensurate with his ability and other demands upon his time.* Some deviation was felt necessary. Time constraints were imposed for each unit to insure acceptable student progress (upper time limit) and to insure administrative readiness (lower time limit). Constraints were administered by offering each of the 11 unit examinations only within a specified span of lessons; for example, the unit 4 examination was offered during lessons 9 through 14. Students were required to attend class, which was actually a study period with a tutor/proctor present, until all course requirements were met. Such constraints were imposed to minimize the threat of incompletes; more latitude would be appropriate as experience with the method is gained.

- *Unit mastery must be demonstrated before advancing to the next unit.* The majority of the students were not majoring in electrical engineering. Since their need for depth of understanding was not firmly established and since retention of the letter grading system was a specified constraint, a unit score of 60% was established as the minimum requirement for advancing to the next unit. Each unit examination could be taken as many as three times; only the highest score was recorded.

- *Lectures and demonstrations should be used as motivators rather than sources of critical information.* In the electrical engineering course no lectures were given. Demonstrations were limited to self-demonstrations, which were related directly to the reading material, implemented within the framework of equipment usage, and almost optional. Students were required to complete five self-demonstrations (30 to 40 were available) and demonstrate results to the tutor/proctor. Since they were not tested on the material, they did not consider them sources of critical information.

- *The written word should be stressed in teacher-student communication.* This was not emphasized; in fact, most communication was via the spoken word except for examinations. The immediate critiques of examinations were always conducted orally.

- *Use proctors to facilitate repeated testing, immediate scoring, tutoring, and enhancement of the personal-social aspect of the educational process.* All of these features were realized through the use of fully qualified instructors as proctors.

An underlying thought in developing the testing and grading system was that examinations should be designed to measure achievement of stated objectives rather than to discriminate among levels of student ability. In other words, student competi-



tion should be with the material and himself rather than with his peers. Further, examinations were to be aids to learning. Unit mastery examinations consisted of randomly selected test items based on the end-of-chapter practice items specified in the unit study guide. Test items were equally weighted and distributed in difficulty as follows: six at level 1, three at level 2, and one at level 3. Each individual in the course received a different examination, and all examinations taken by any one individual were also different. Computer-generated random numbers on standard IBM cards provided the mechanism for making the random choices of test questions; the questions themselves were contained in booklets. The grading system could loosely be called "contract grading." The student could practice and continue taking tests, up to three times per unit within the time constraints, until he reached whatever level he chose; he was graded consistent with his effort.

SO MUCH for the composition of the course. Some have asked the question, "Did you really self-pace?" The answer was, "Yes, with realism." In spite of somewhat rigid constraints, the students were indeed able to pace themselves by studying and testing when ready. The time constraints could very easily be removed, but until the remaining courses in the overall environment are offered in a similar format, the upper time limit of one semester would have to remain. Others have questioned the validity of the experiment on the basis of the relatively ideal conditions at the Air Force Academy; that is, excellent resources, maximum of 16 students with one instructor per section, above average motivation, etc. Although these conditions do prevail, it is not felt that they detract from the validity or the generality of the observed results.

Student reaction to the course was measured by questionnaire. All samples (116) were nonelectrical engineering majors since their reaction to the core course was of primary concern. (Responses were grouped for analysis and comment under headings indicated below. Percentages are rounded to the nearest whole percent.)<sup>12</sup>

- *Course in general.* The same or a more favorable attitude toward electrical engineering, compared to the beginning of the course, was indicated by 99% of the respondents; 60% increased and 49% showed a preference for further study in electrical engineering. Total study time per lesson was indicated as 1 to 2 hours by 72%; 81% admitted less study time than in other courses.

- *Course material.* Above average in interest: 72%. Above average in difficulty: 58%. Above average in practicality: 58%.

- *Self-pacing method in general.* A strong preference for self-paced study was indicated (90%), apparently based on the feeling that the material was made easier (58%), that the amount learned was greater (61%), and that the autonomy offered by the method was appreciated (89%). Ninety percent felt that the course material was well suited to the self-paced method.

- *Self-pacing—our version.* Motivating factors were ranked as follows: multiple testing, finishing the course early, choosing grade by level of achievement, no lecture, and autonomy. Retesting was considered a significant aid to learning by 99%, which suggests a desire for self-improvement mechanisms. The data revealed that the upper and lower bounds on progress had little effect on their rates of progress. The absolute grading system was considered good to excellent by 90%, 78% indicating that they also felt it was a valid discriminator. Tests were rated as average in difficulty by 92%; also fair and representative

by 85%. Study guides were rated very useful by 14%, useful by 44%, marginally useful by 30%. Unit behavioral objectives were rated very useful by 13%, useful by 32%, and of marginal value by 40%. Practice items specified in the unit study guides were found very useful by 21%, sometimes useful by 50%, and of marginal value by 19%.

- *Integrated-classroom environment.* Increased understanding was perceived by 86%. The integrated-classroom environment was preferred by 95% to the traditional classroom and laboratory environment.

- *Grade distribution.* A-57%. B-36%. C-7%. There were no D's or F's.

INSTRUCTOR reaction to the course was varied, although the efficacy of the method was generally acknowledged, at least for basic courses. Some preferred the challenge of lecturing. Others welcomed the challenge of tutoring, which was limited by the practical necessities of testing, grading, and overall administration; it was felt that automation would be an invaluable aid in these latter areas. In general, instructors favored the method, especially if the administrative kinks could be worked out.

Conclusions about the program should be tempered with the recollection that the experiment was conceived and executed in a basically hostile environment. Although probably the most liberal of the service academies, the Air Force Academy is not a liberal institution. Caution was the rule; every move was carefully considered in light of the fact that this was the first self-paced course at the Academy. Some expected—perhaps even hoped—that it would fail and thus end such radicalism for some time to come; unnecessary constraints and limited goals were therefore practical ingredients in the planning process. Perhaps

the most significant observation made was that the experiment was quite successful in spite of such rigid conditions. Student acceptance of the course was unprecedented in the electrical engineering core sequence. Instructors were enthusiastic in their attempts (for some, their first) to manage the learning process rather than direct it from the podium. Both student and instructor reactions to the increased personal-social aspects of the educational process were most encouraging. Finally, all of the results were generated with no increase in resources of any kind.

In addition to making the course more relevant, motivating, and reasonable, it was hoped that self-pacing might be more cost-effective, resulting in the same amount of learning with fewer instructors. A firm basis for such a hope did not emerge from the experience. Given excellent preparation and smooth administration, probably more students could be accommodated per instructor (tutor) than the usual 16 per section, but such saving is more likely to be achieved in basic courses than in advanced ones. There may be a point in course complexity beyond which self-pacing is not optimal, either in terms of learning or manpower.

Initial conditions are the best predictors of the effectiveness of a self-pacing experience. The reading materials should be the best possible, since they are the student's primary source of information; poor materials are an imposition to both student and teacher. Extensive prior preparation, including well-written, measurable objectives and suitable practice materials, should be ready when the course begins. In a comparison of the self-pacing mode with the lecture environment, that time which would normally be devoted to lecture preparation throughout the semester should be expended on course preparation *before* the self-paced course begins.



Student accommodation to self-pacing was found to be especially sensitive to student background and experience. A student can survive in a lecture/grading-curve environment without understanding much, whereas in a self-paced situation, he must demonstrate mastery before proceeding. Those who were weak in prerequisite knowledge suffered (with the tutor) through a catch-up period. It is desirable, in the long run, that self-paced courses with absolute grading standards exist in harmony with other courses having similar standards, especially prerequisite courses. Extensive soul-searching and coordination on both interdepartmental and intradepartmental levels are necessary if self-pacing is likely to play an important role in an institution's curriculum planning.

Finally, no evidence suggests that self-pacing is academically sterile or dehumanizing unless its planners make it so. There are ample opportunities for creativity and meaningful problem solving, both for the student and (especially) the instructor. When imaginatively designed and executed, it is an individually guided method that lends itself well to almost any instructional situation and any desired degree of administrative control. Assuming adequate preparation and reasonable objectives, its likely long-term benefits are increased cost-effectiveness through increased learning (assuming no increase of resources), greater fulfillment on the part of both students and instructors, and greatly improved study habits. Indeed, it may start the student on a lifetime of self-education.

*Air Command and Staff College*

#### Notes

1. L. Ludlow, "At a Lecture—Only 12% Listen," *San Francisco Sunday Examiner and Chronicle*, September 1, 1968.
2. G. H. Flammer, "Learning as the Constant and Time as the Variable," *Engineering Education*, March 1971.
3. R. M. Gagne, *Conditions of Learning* (New York: Holt, Rinehart and Winston, Inc., 1965).
4. R. F. Mager, *Preparing Instructional Objectives* (Palo Alto: Fearson Publishers, Inc., 1962).
5. W. H. Burton, *The Guidance of Learning Activities*, 3d ed. (New York: Appleton-Century-Crofts, Inc., 1962).
6. L. Harnshurger, "Self-Paced Individually Prescribed Instruction," *Engineering Education*, March 1971.
7. The effort was initiated and guided by the Professor and Head of the Department of Electrical Engineering at the Air Force Academy, Colonel Roland E. Thomas. Course materials were researched and generated by Major Daniel W. Buehler, Major Richard N. Miller, and the author.

8. R. E. Thomas and D. W. Buehler, *Signals and Systems*, vols. I and II, USAF Academy, Colorado.
9. R. E. Thomas and C. W. Mitchell, "An Integrated-Classroom-Laboratory," *Educational Research and Methods (ERM)*, Publication of a Division of the American Society for Engineering Education (ASEE), vol. 4, nr 1, October 1971.
10. Mager, *op. cit.* R. B. Wainia, *Evental Specification of a Curriculum: An Overview*, RAND Document No. D-17822-PR, and *Specification of Educational Objectives for System Evaluation*, RAND Document No. D-17846-PR (Santa Monica: The RAND Corporation, September 27, 1968).
11. F. S. Keller, "Goodbye, Teacher," *Journal of Applied Behavior Analysis*, Spring 1966.
12. Comments on analysis of the experimental course are either quoted or paraphrased from a letter entitled "Evaluation of Self-Paced EE 351, Fall '71," addressed to DF (Dean of the Faculty, USAF Academy) and signed by Col. Roland E. Thomas, Professor and Head, Department of Electrical Engineering.

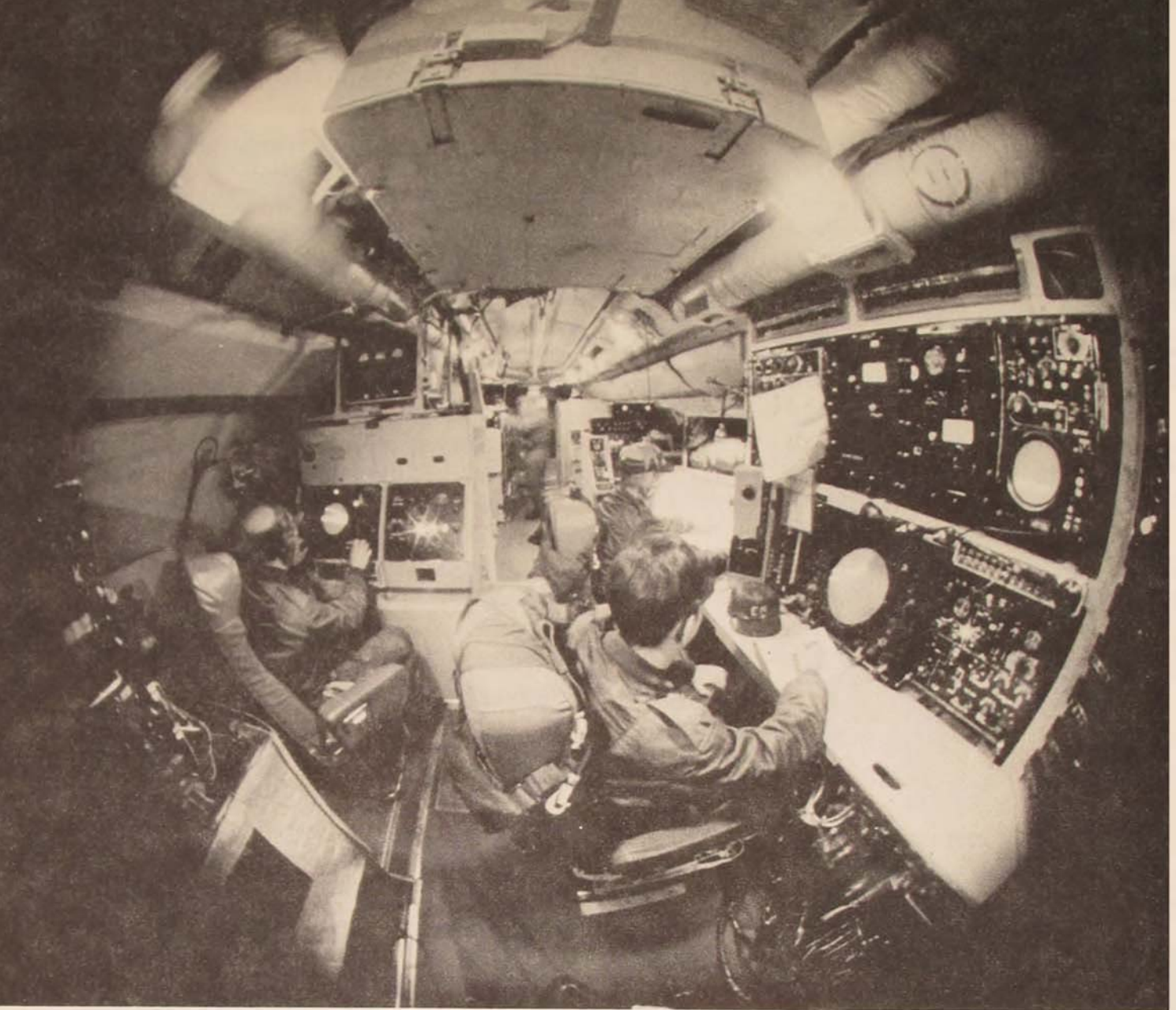

## 552d AIRBORNE EARLY WARNING AND CONTROL WING IN SOUTHEAST ASIA



*a case study  
in airborne  
command and control*

LIEUTENANT COLONEL JEROLD R. MACK  
CAPTAIN RICHARD M. WILLIAMS



THE Defense community widely holds as axiomatic that basic doctrine is best derived from experience gained in combat operations. Extensive historical programs, both retrospective and contemporary as well as the disciplines of operational and systems analysis, are testimony to the need to exploit this avenue of continual refinement, identifying and capitalizing on lessons learned in the throes of armed conflict. The conflict in Southeast Asia (SEA) marked the first combat tactical employment of an airborne radar platform in a command and control role. Accordingly, the lessons learned there are especially vital to determining operational doctrine to guide future employment of current and follow-on airborne command and control.

Certainly something can be learned from the COLLEGE EYE Task Force (CETF)—the deployed element of the 552d Airborne Early Warning and Control Wing—and its role in Southeast Asia, for deployment of the task force marked a dramatic departure from the traditional role of the EC-121. Designed and optimized for overwater radar detection to provide seaward extension of North American Air Defense Command's contiguous radar coverage, the EC-121 was only marginally suited to the demands of the Southeast Asian tactical environment. Notwithstanding known deficiencies, the value of such a system was evident (though not universally recognized): it offered radar surveillance, warning, and autonomous weapons control capabilities where they had not existed.

So it was that in adapting themselves to this environment and aggressively pursuing the necessary changes to upgrade their responsiveness, the hard-core "believers" managing the task force transitioned an unwanted detachment into an extremely viable command and control force. The principal lessons to be studied, therefore, are those learned in this process.

The death of traditional Airborne Early Warning and Control (AEW&C), characterized by its primary emphasis on surveillance extending ground-based coverage, was not mourned, for with it came the birth of a new era in the discipline of airborne command and control. In the evolutionary process, the EC-121D, mainstay of AEW&C, became the "EC-121D+," incorporating add-on equipment to enhance its capability in SEA. Later, extensive retrofit gave the aircraft a new series designation, EC-121T, to be known as Airborne Surveillance and Control System (ASACS). The next milestone, yet to be realized, is an operational Airborne Warning and Control System (AWACS) that will repackage each subsystem proven essential into state-of-the-art hardware and a modern airframe.

#### Big Eye/College Eye Task Force Formed

Sunday, 4 April 1965, heralded the deployment of the Radar Constellations to Tan Son Nhut Air Base, Republic of Vietnam. The contingent was initially called BIG EYE and existed only as a mobility plan with its chain of command as Pacific Air Forces/Thirteenth Air Force/Second Air Division/BIG EYE. It later became COLLEGE EYE when Air Force Manual 205-1 was changed to assign standardized first words by command for use as project nicknames, and after February 1967 it operated from Thailand.

The settling-in phase was an arduous period fraught with resistance from all sides. The BIG EYE capabilities were not widely appreciated, which resulted in an

*This article on airborne command and control is the second in a series of articles in Air University Review concerning roles of the Aerospace Defense Command.*

atmosphere of suspicion from both the potential users of the service and the command structure that was responsible for operational control.

Through this turmoil and confusion surfaced the one hidden ingredient that gave BIG EYE an edge: twelve years of experience in the AEW&C business. Departing TDY as combat-ready crews, the large aircrew complement had long since polished internal procedures. To a man, they demonstrated uncommon enthusiasm in meeting the challenge of this new mission. These factors contributed to successes beyond the expectations of those knowledgeable concerning the system's limitations imposed by inherent design characteristics and antiquated equipment.

The task force was augmented by two aircraft within the first month. The initially assigned mission was to fly orbits over the Gulf of Tonkin for surveillance of any hostile activity and control of the USAF fighter Combat Air Patrol (CAP) providing protective cover for airborne forces in the area.

When the initial 30-day period expired, BIG EYE became a very controversial issue. Should it stay or go home? Many skeptics felt it should leave; but, its initial value to the war effort having been established, it was retained for an indefinite period. Thus began the eight-year TDY of rotational 552 AEW&C Wing elements.

With such grave equipment limitations and command-established procedural concepts that did not lend themselves to the task force's mode of operation, actions had to be initiated to resolve the deficiencies.

### College Eye Task Force Upgrade

The first order of business was to develop tactics and techniques to circumvent the design shortcomings, at least the most significant ones: (1) inadequate radar clutter rejection to allow overland detection;

(2) manual, passive, one-at-a-time identification friend or foe/selective identification feature (IFF/SIF) decode; and (3) unreliable line-of-sight communications.

CETF was charged with the responsibility of providing radar coverage of the Red River Delta, a pie-shaped sector with its vertex northwest of Hanoi, broadening out to the irregular coastline stretching from Haiphong harbor approximately 60 miles to the southwest. A normal mission profile with medium flight altitude produced massive ground returns that blanked any aircraft radar returns from the area, though IFF/SIF coverage was excellent. To overcome this handicap, a low-altitude technique was employed for the second aircraft on station, putting the horizon between the airborne radar platform and the land mass and thus removing the clutter-producing terrain from line-of-sight. The word *low* is emphasized. Station altitude was adjusted for each mission to optimize radar performance for variables in sea state and propagation. With this method, a clear radar picture was achieved, at the sacrifice of low-altitude coverage over the land mass.

Since the nature of surveillance responsibility knows no beginning or end, the radar crews were occupied with the continual process of detection and identification of air traffic. With only the AN/APS-95 search radar and AN/APX-49 IFF/SIF recognition set available, manual correlation of radar returns with an offset SIF display was a never-ending process. The volume of traffic was immense, and identification of friendly forces became a major workload, further compounded when fighters did not "squawk" or meet their flight plans. The task force strove, through a vigorous "sales campaign," to enlighten all its customers as to its capabilities/limitations, and by this method developed procedures for a check-in/check-out to speed the process. This afforded personalized (by call sign)





*This EC-121 is typical of the D and T models discussed in the article and represents existing USAF airborne radar command control resources.*

flight-following, which saved valuable reaction time if a threat was launched against them or they experienced an emergency over hostile territory.

Communication was a constant uphill battle for the task force. Regardless of the clarity of the tactical air situation to the on-board weapons controllers, there is no command and control without ability to pass this information to those who must react to it. COLLEGE EYE was handicapped by an aging, low-power UHF set, which was unreliable in providing this vital link. The line-of-sight communication problem was further complicated by low-level station-keeping, mountainous terrain, and friendlies at medium altitude. When on target, the fighters were almost always out of radio contact with the radar platform. Gravely concerned by this situation, the task force started a crusade for assignment of radio relay channels dedicated to their use, so that real-time situation information could be fed through a high-powered radio relay platform "guaranteeing delivery" to the friendlies.

Concurrent with these procedural methods, the task force launched a full-scale program to obtain minimum lead-time retrofit for inadequate hardware plus new, advanced state-of-the-art "add-ons" that would enhance the system in the key areas of hostile detection, friendly beacon tracking, and line-of-sight communications. A secure cross-tell capability and other classified programs were initiated to greatly enhance on-board threat assessment and lateral information exchange. When realized, this equipment formed the package previously identified as the "D+" model, which became fully operational in SEA prior to the bombing limitations announced by the President on 31 March 1968. Although minimal modification in terms of dollars, lead time, interface, or technical sophistication, integration of this equipment represented substantial qualitative improvements.

In turn, the increased system capability demanded new autonomous control authority and operational procedures. This is best demonstrated by a "before and after" look

at the threat-warning process. Although threat-warning formats varied in different time frames, those used in the earlier years shared the following characteristics:

(1) Given on "Guard" (243.0 MHz) for all to hear.

(2) Area warnings, tied to ground reference systems such as GEOREF, color-coded areas, or sectorized concentric circles from a reference point.

(3) Most often nonspecific as to type, quantity, heading, speed, altitude, or apparent intent.

(4) Issued too frequently by the same, or different, agencies without correlation as being either updated or additional threat reports.

(5) Issued "in the blind" and therefore

unacknowledged, which always left receipt in question.

From the beginning, COLLEGE EYE recognized the problems this created for the strike pilot and could envision the hardware and procedural changes necessary to resolve them. Unfortunately, the changes could not occur overnight. With multiple transmissions on "Guard," air-to-air "chat-ter" on discrete tactical channels, which was vital to coordinating final strike profiles, was often blocked. Area threat formats required each pilot to estimate his position in the same ground reference system first, then compute relative position of the hostile to assess the threat. This process took time, interrupted concentration on other vital in-flight procedures, and unnec-

*The Airborne Warning and Control System (AWACS) depicted here (right) portrays the follow-on system being developed by the Boeing Company from the basic 707-320B Intercontinental airframe. . . . USAF F-102s intercept a Soviet Bear. Control of this type activity is a common occurrence for EC-121 aircrews now in their worldwide-employment role.*





essarily concerned flights to which the hostiles posed no threat. When analyzed as a potential threat, the large area encompassed within the threat warning (necessary to compensate for its non-real-time nature) and its nonspecific information left the friendly with little more than a heads-up warning. He had no idea if a challenge would materialize, or when, or if it might come from port, starboard, astern, or head-on. Did he jettison his ordnance and prepare for aerial engagement? Did he alter his ingress/egress route? Did he split out his flight? Did he press on as planned? There was little help in answering these questions. It is small wonder, then, that out-country flyers had little faith in the warnings issued, nor were they interested

in excuses for the shortcomings. They are important in retrospect, however, if we are to learn the lessons.

We required the ability to pass real-time threat warning by flight call sign directly from COLLEGE EYE to the threatened aircraft over discrete control channels, giving hostile position in relative range and bearing. This necessitated improved detection capability, rapid identification of friendlies, reliable line-of-sight communications, and other improvements of the D-model "add-on" configuration.

Because of its integration as an extension of the semiautomatic ground environment (SAGE), the EC-121 had not been configured for the identification responsibility. Whereas the system originally deployed was lim-



ited to one-at-a-time passive decode of SIF returns, the D+ configuration, with its AN/GPA-122, allowed each weapons controller to passively track six discrete SIF codes, selectively identify any one of the six in real time, and actively read out the mode and code of any squawking aircraft as fast as he could "gate" the return (similar to the light-gun technique used in SAGE and other ground environments). Such capability was a first step toward realizing the discrete warning process discussed earlier.

Similarly, retrofit of obsolete UHF sets with the latest inventory item, AN/ARC-109, and assignment of additional external high-power relay channels gave COLLEGE EYE the ability to communicate with selected elements of the strike force throughout their mission profiles. When fully implemented, the procedures called for three discrete UHF frequencies, assigned to the wings from which most strike forces were drawn. Complementing systems, increased lateral coordination, and procedural discipline resolved the few remaining problems previously identified. While threat warning was used as an example, other taskings benefitted equally from the equipment upgrade.

After March 1968

The bombing cease did not end the COLLEGE EYE efforts but simply altered their direction. The task force entered a period of tailoring its capabilities to the requirements of the remaining combat missions in SEA. The total Aerospace Defense Command EC-121 force found itself tasked to support JCS-directed commitments worldwide, performing many diverse missions against a number of mobility plans in support of global contingencies.

Even though the SEA employment had less emphasis, there was no corresponding

curtailment to extensive modifications in progress to upgrade the D+ to a fully automated EC-121T. This second step in a two-phase transition in system configuration followed updated thinking that placed airborne command and control resources in a worldwide role. In response to these changes and to avoid stereotyping, the name was changed from Airborne Early Warning and Control to Airborne Surveillance and Control System (ASACS), which would more closely associate it with the next phase, the Airborne Warning and Control System (AWACS).

The ASACS retained all basic EC-121D capabilities plus those derived from thirty-three additional major end items of hardware. Enhanced capabilities include

- IFF/SIF beacon tracking/decode through a real-time on-board digital computer
- Computer "rate-aided" tracking of manually initiated hostile detections
- Addition of symbology to display systems
- Computer-assisted intercept control programs
- Computer-formated air-to-air control data link message transmission
- Software flexibility to tailor tactics to mission type and geography
- Capability for in-flight reprogramming to adjust to dynamic tactical situation
- Redundant digital data down link (beyond line-of-sight and relayed line-of-sight media)
- Secure, high-power, beyond line-of-sight voice mode
- New navigation systems and computer interface to increase radar stabilization accuracy in ground reference
- Other classified complementing subsystems to enhance real-time battle management, warning, threat assessment, and weapons control functions.

The vision gained in SEA toward the worldwide application of airborne command and control was not lost. ASACS is



*Radarscope. Crew members of 552 AEW&C Wing examine the presentation on one of the aircraft's five radar display consoles.*

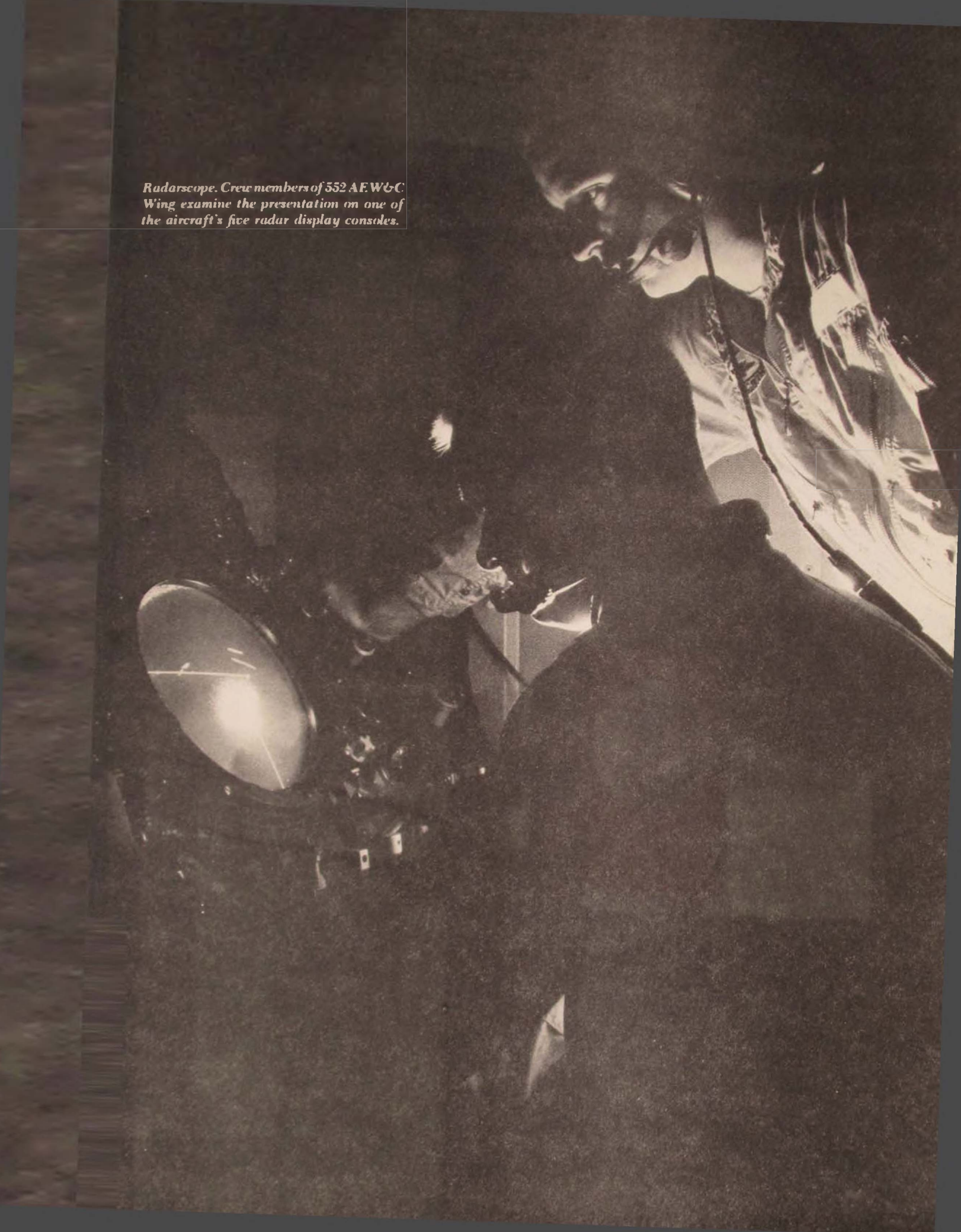

still in the stage of operational refinement. Expertise derived in the brief but intense interaction between the add-on configuration and combat forces is being exploited to bridge the gap between present-day resources and the fruition of a state-of-the-art follow-on.

The continuing development of ASACS, encompassing the embryonic stages of AWACS, is guided by a newly commissioned System Support Facility (SSF), truly the nucleus of the system.

The SSF was designed to provide organic design, testing, production, and analysis of computer software, to maximize the system's responsiveness to any environmental/tactical changes. It also provides system diagnostic support and dynamic crew simulation. Through this facility will come the reality of interfacing ASACS with all major environments.

Ongoing emphasis is being placed on conducting exercises with all commands and services, from which can be gleaned knowledge and skill vital to making ASACS viable to command and control needs.

Throughout this eight-year development, one common ingredient is noted. Continued successes have been achieved through the dedicated efforts of a small body of believers, charged with single managership. These specialists, often with an entire career devoted to this single discipline, applied their years of experience in airborne radar technology within this single-managership concept to realizing accomplishments not otherwise obtainable. Through single managership, airborne command and control has grown and will continue to grow into a responsive system providing immediate reaction to a dynamic threat. The 552 AEW&C Wing's vast experience in airborne early warning and control, teamed with ADC's unequalled knowledge of radar command and control systems, has provided expertise in depth, allowing sys-

tem development beyond anything ever envisioned for the EC-121. Originating as a by-product of ADC's single CONUS role, airborne command and control by ADC in a global role has since become a way of life.

THE EMPLOYMENT of the 552 AEW&C Wing's resources in Southeast Asia confirmed without doubt the validity of USAF Basic Doctrine, which states the requirement for airborne command and control to exhibit characteristics of survivability, mobility, responsiveness, and tactical versatility. That employment further defined the requirements for follow-on systems and afforded a proving ground for both system employment and procedural techniques. The data base so derived is invaluable to the current development of follow-on systems.

Such a requirement knows no geography or set scenario. System design therefore must incorporate the flexibility necessary to respond worldwide to dynamic tactical situations. In peacetime, caution must be exercised to avoid so optimizing the system to a particular role that flexibility is lost.

To maximize the effectiveness of the limited fleet size that may be reasonably expected in the current fiscal atmosphere, the single-manager concept should be maintained for current and follow-on systems. Should developmental or appropriation milestones slip for the AWACS, the ASACS program should be continued to avoid a lapse in operational capability and provide smooth transition into the new airframe.

When priorities for future Defense dollar allocations are being weighed, airborne command and control must receive enlightened recognition as an essential, cost-effective element of any total force structure.

*AWACS Special Project Office  
and  
Hq United States Air Force*



# THE DEFINITION OF OPERATIONAL REQUIREMENTS FOR COMMUNICATIONS

MAJOR CHRIS N. WILCOX

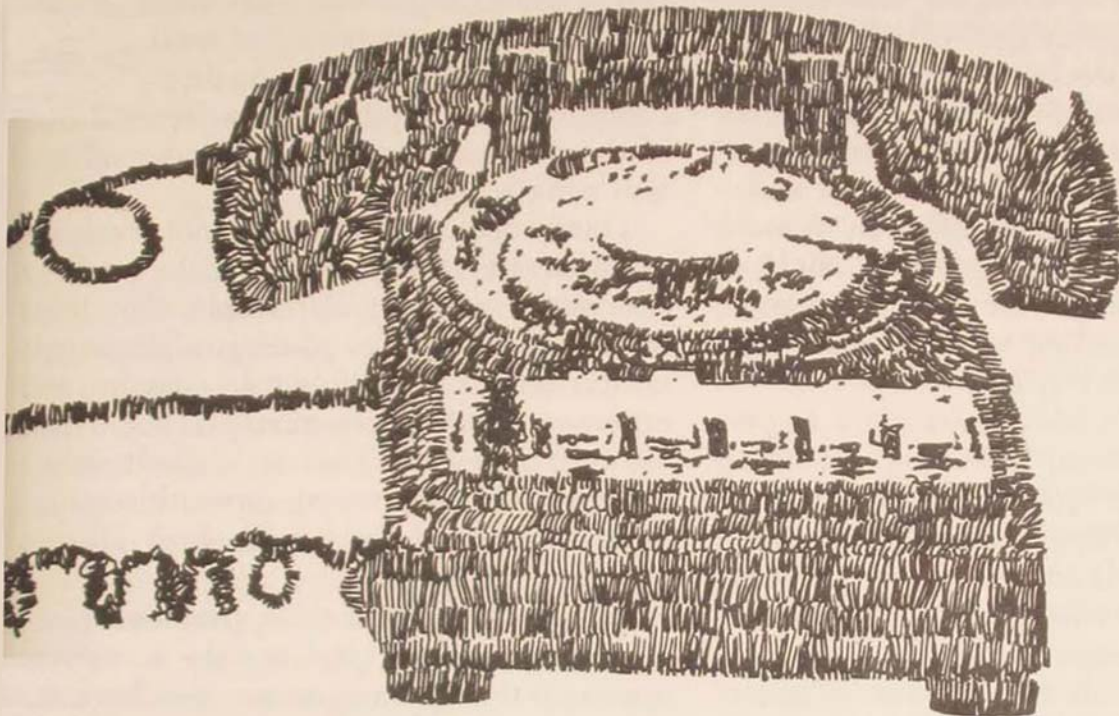

ONE of the crucial problems in the communications-electronics management area is assuring that systems and services remain responsive to Air Force needs in the face of changing technology, restricted resource climates, and revised concepts of command and control. Solving this problem requires effective planning, which depends in turn on the accurate and timely definition of operational requirements.

As used here, the term “operational requirements” pertains mainly to the basic needs of operating organizations for communications services such as command and control channels, data links to computers, air/ground radios, or telephones that are essential for accomplishing the Air Force’s mission. Operational requirements must include sufficient detail to quantitatively describe the service required, for example: range, accuracy, reliability, or security. Not included are technical and

support considerations that pertain to finding the best or most efficient way to provide a service; these are design considerations.

### The Requirements Problem

The collection and analysis of requirements constitute a complex undertaking, hampered by a great deal of inherent uncertainty and imprecision. Informed opinion often differs concerning the validity of individual requirements and the accuracy of their specifications. While the use of analysis and systems engineering can remove some of the subjectivity regarding individual requirements, a number of problems remain, particularly in dealing with the communications picture as a whole.

First, there is a need for a more aggressive approach toward collecting and sifting requirements. Dr. John S. Foster, Jr., Director of Defense Research and Engineering, warns that the military must use "a specific effort by competent people" to identify deficiencies in peacetime so that they will not surprise or haunt us in war.<sup>1</sup> Clearly, such an effort must be thorough and comprehensive. For example, in addition to inspections for procedural compliance, there must be thorough, searching analyses of the procedures themselves. In addition to knowing that systems are operating as designed, it is important to know if the design itself is still responsive to the mission. Also, it is implicit in Dr. Foster's warning that planners seek to forecast requirements rather than wait until the needs become obvious; otherwise, there may not be time to respond.

Second, more attention must be paid to relationships between requirements. Considerations of commonality and interoperability tighten the coupling between otherwise unrelated requirements. Although our experience as far back as World War II

and Korea showed the necessity for standard communications equipment, for the past fifteen years the growing utility of computers and leased communications services has led to a lapse of standardization in favor of cost savings and special responsiveness considerations. Now the costs of computer systems, needs for interfaces between previously separate systems, and centralized control of the strategic forces are reversing the trend. But the very efforts of making interfaces and seeking commonality severely complicate the requirement process because of the necessary trade-off and external system considerations.

Third, decision-makers cannot evaluate requirements in isolation. To make resource allocations as wisely as possible, they must have a mechanism for placing requirements within the context of higher missions and other competing requirements before assigning priorities. This is difficult when commands develop and forward requirements piecemeal for approval, as current procedures allow.

In order to address these problems more effectively, it is helpful to take a systems approach toward requirements identification and analysis. Although there is an identifiable method to the systems approach, it is more properly described as a frame of reference whereby the planner thinks in terms of groups of requirements and their interrelationships rather than isolating requirements to simplify the solution. The broader view has an obvious appeal, but there are significant pressures that make it easier to deal with narrow rather than broad requirements. The narrow requirements are easier to analyze, understand, articulate, fund, and solve. Thus, the planner is tempted to simplify his requirement statement, defining away peripheral problems, limiting the scope of his analysis. While this simplifies his immediate analysis problem, the method fails to give a complete picture of



deficiencies, forces decision-makers to make judgments without a full analysis of the problem, and exacerbates interfacing and commonality problems.

It is neither possible nor desirable to do away with the analysis of discrete requirements, but it is necessary to increase that dimension wherein individual requirements can be considered as part of the larger context. In this way commonality can be better addressed, more deficiencies surfaced, needs better tied to objectives, and requirements "prioritized" and compared.

### A Systems Approach

There are basically three steps to requirements development: collection, specification, and integration. Collection concerns the surfacing of requirements. Specification is the process of determining those qualitative and quantitative parameters that describe the requirement and yield design criteria. Integration involves presenting the requirements in a consolidated, time-phased plan and linking them to command objectives and operational concepts. Through all three steps, systems analysis and systems engineering techniques play a vital role. The following paragraphs emphasize the requirements process at a major command headquarters, but the same steps apply at other echelons as well.

#### *the role of systems analysis*

Disciplined analysis is essential to each phase of the requirements process. If properly applied, the methodology yields quantitative information about requirements to assist in establishing priorities, deciding when improvements are needed, determining which improvements are worth the cost, and gaining approval for programs. Van Court Hare lists six basic questions that systems analysis can help answer:

- What are the system boundaries?
- How does it operate?
- Does it work as predicted?
- Why does it fail to work as specified?
- Can it be improved?
- What are the effects of change?<sup>2</sup>

The first question is particularly important because we often define our systems in too limited a way. System boundaries are sometimes drawn at the point where communications hardware leaves off. Considerations of the user and his operations or of systems that must interface with the communications networks are then neglected.

For example, commands sometimes reduce the number of AUTOVON access lines at air bases when operations and maintenance funds are tight. Although the commands know how much communications money is saved, they can only estimate the cost of such cuts to the user. The system boundary for analysis purposes has been drawn between the telephone and the user. But calls take longer to establish, and users spend more time dialing. Who knows what this costs in terms of office efficiency? Perhaps only a little, perhaps a lot. The costs may considerably exceed the dollars saved. In any case, the cost of degraded service to the user is a valid, essential economic consideration. It is easy to lose sight of such factors when system boundaries are too narrowly defined in the analysis process.

Hare's other questions are more straightforward. Communications organizations have always been interested in the answers. However, formal analysis should be increased and used on a continuing basis to explore the answers in terms of basic operational requirements. More attention to the analysis disciplines can pay dividends by bringing precision to an otherwise subjective requirements process. The following paragraphs explain the steps and show in more detail how systems analysis can contribute.

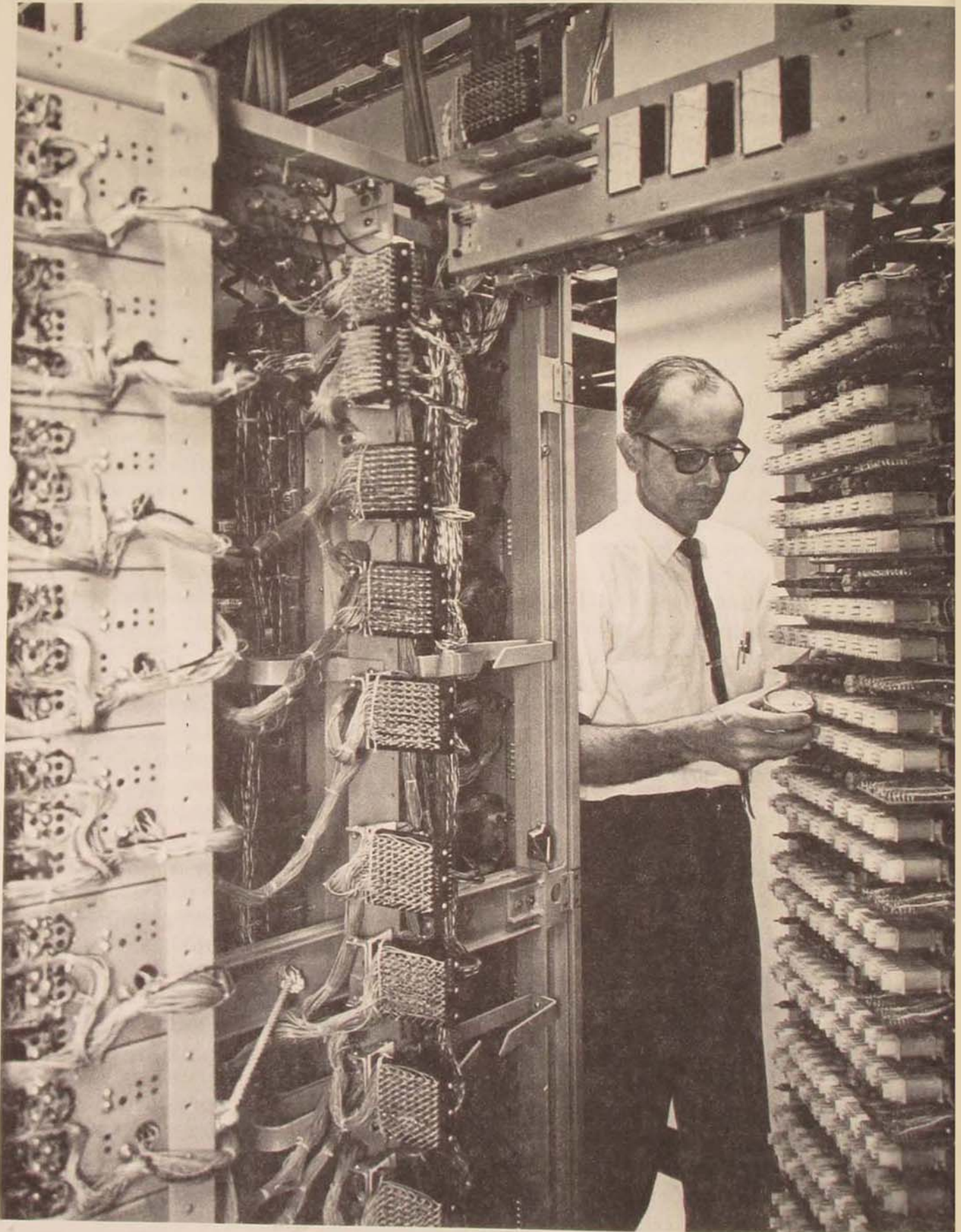



*Testing some of the hundreds of relay units in the electronic switching center near Polk City, Florida (left). Built, operated, and maintained by General Telephone Company of Florida, it is one of about 80 links in the DOD AUTOVON global network. . . . The status control board indicates by computer print-out and flashing lights any trouble located by the switching equipment.*

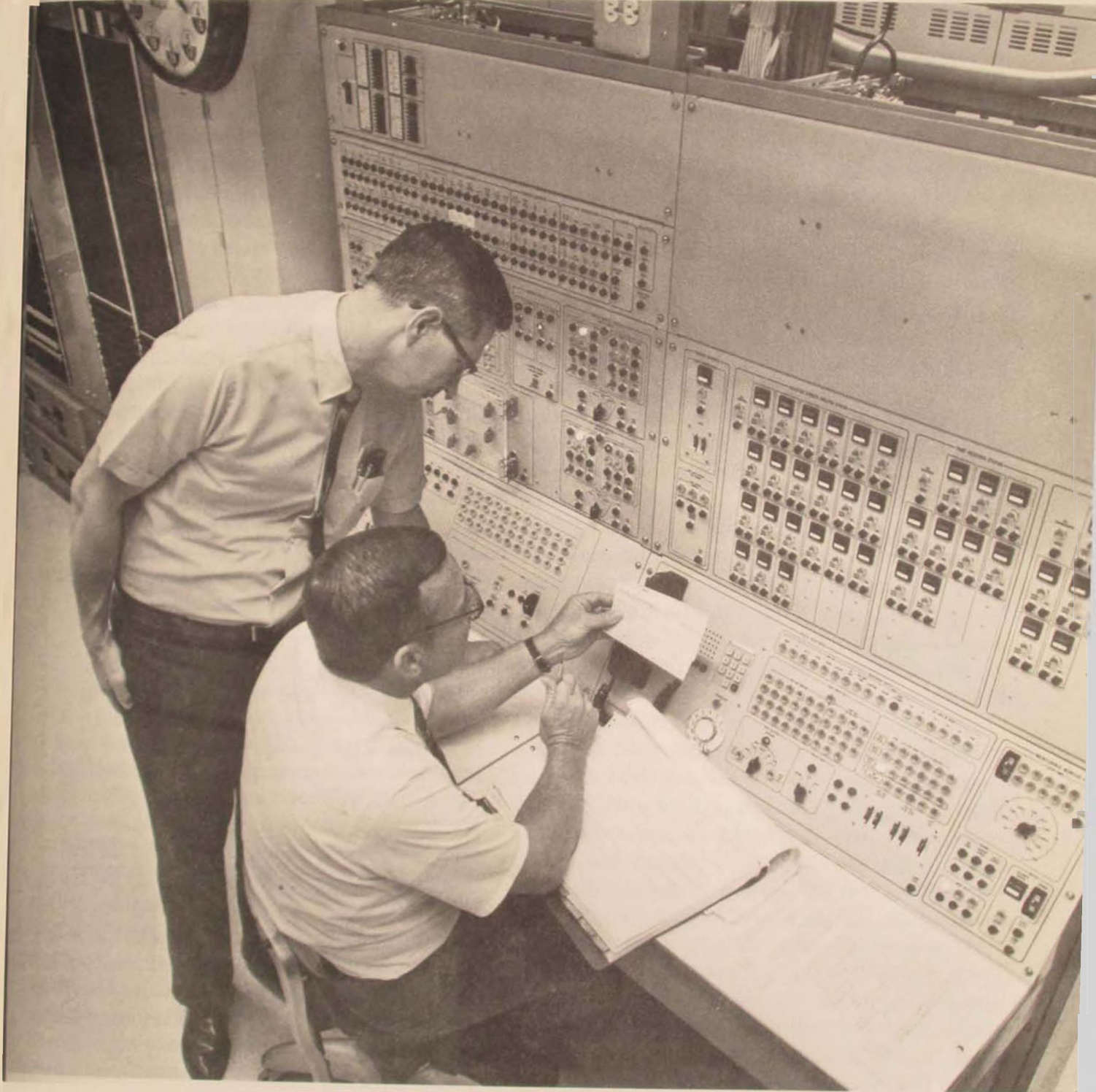

*requirements collection*

The first step is collecting requirements. They can be surfaced in a number of ways: demand-pull; technology-push; analyses of system operations; study of operations, logistics, contingency, and other kinds of plans; and, finally, through interviews. Each of these techniques, assisted by thorough systems analysis, can make significant contributions to the development of an accurate, integrated picture of communications requirements. Used together in a systematic way, they can yield the steady flow of information necessary to keep the requirements picture current and to allow timely planning and forecasting.

Demand-pull is the source of most short-range requirements. The customer has a specific problem. Where the need relates directly to a unit's mission, justification is straightforward. Needs for hot lines, closed-circuit television, or common telephones fall into this category. Some demand-pull requirements involve the acquisition of extensive communications networks or costly research and development programs. The Semi-Automatic Ground Environment (SAGE), for example, resulted basically from a demand-pull requirement as the Air Force sought a better means for controlling air defense operations.

Although all valid requirements for communications services and systems would surface sooner or later by this method alone, there is a major pitfall. If the communicator relies solely on demand-pull, he will frequently learn of the requirement too late to respond to the user's required operational date. Lead times for system design and acquisition are usually measured in years, particularly for nonstandard facilities and services. Further, there is the increased cost associated with crash programs; systems come cheaper through orderly planning. This in turn requires forecasting and

the aggressive collection of requirements.

Telephone service in New York City, for example, has been in relative chaos because New York Tel's forecasting for the late 1960s and early 1970s failed to predict a future surge in demand. The company had curtailed investments in expanded facilities and was not able to respond fully.<sup>3</sup> The result was lost revenue for the telephone company, inability of many customers to obtain the service they required, and a loss of public confidence. Air Force communications are susceptible to the same problem. Communications planners cannot rely solely on demand-pull. They need active measures to ferret out requirements and forecast resource demands.

Technology-push is one means of stimulating requirements inputs. Through a continued awareness of the capabilities available from an expanding technology, the communicator is sometimes in a position to suggest technological innovations to improve existing services or to offer entirely new ones to subscribers. Similar suggestions will also come from contractors. In either case, the mechanism is technology-push.

There are some dangers, however. According to Dr. Foster,

We have met with some success in the past by using the approach of selecting promising new technology and then identifying applications that improve our capabilities. But this approach—a solution looking for a problem—too seldom strengthens our weakest link. . . . Unless we emphasize the programs that are founded on valid deficiencies and also represent demonstrably effective solutions, we waste millions, we diminish deterrence, and we risk lives and property.<sup>4</sup>

Planners can best find the weakest link by thorough analysis of existing systems, but to do so they must be careful to define the boundaries properly. Most communications organizations employ regular procedures for analyzing such functions as switchboard



operations, communications centers, radio networks, and maintenance performance. Although these procedures yield valuable measures of efficiency, responsiveness, and other factors relating to specific operations or systems, rarely do organizations analyze communications as a whole: relationships between systems, user considerations, value of the services performed, or the continued utility of services in a changing environment. This can be a serious shortcoming.

Communications organizations must apply the analysis disciplines more extensively to the examination of communications systems in a broader context. They do this from time to time through special study groups, but this does not maintain the continued emphasis on requirements analysis so essential at major command level. Requirements change. Their continued analysis is part of the command planning cycle and a valuable input to the decision process. The requisite up-to-date knowledge about them cannot be obtained through a periodic kind of analysis whose results soon become outdated.

A fourth source of communications requirements is the study of operations, contingency, developmental, logistics, and other kinds of plans. These plans often specify directly what communications are required for support. One must be careful, however, to analyze the plans for any hidden support considerations. When the plan is brought to fruition, hidden requirements will come out, usually on short notice. They are much easier to solve in advance.

Also, it is axiomatic that planners should assess the cumulative effect of various plans on the communications systems that support them. Taken individually, each of several plans may levy support requirements that are well within the capabilities of current systems. Taken together, however, the plans may call for more communications than are available. If the plans are likely to be exe-

cuted in parallel, planners must assess the aggregate requirement.

The last technique, systematic interviewing, although infrequently employed, is a good way to survey a command or a headquarters to determine how the managers and operations personnel view their long-range needs for communications. The replies should be put together in a mosaic to form an input to the long-range requirement process. The interview process taps the flow of unstructured ideas that circulates within a headquarters or operational unit. In a sense, the interviewing is like an organized brainstorming session with the users of communications. It produces a wealth of information not otherwise available.

Each technique for surfacing requirements yields important results, but the techniques are best used in concert. No single method gives all the information needed for accurately projecting communications requirements. The emphasis placed on each method should vary with the circumstances. At the unit level, for instance, demand-pull and the study of plans would be more useful than the other techniques. At any organizational level these two techniques tend to produce the shorter-range requirements. Interviewing is more fruitful at major command level in the process of developing long-range requirements estimates, and then on a periodic rather than continuous basis. Although systems analysis techniques can be used at any level, the special expertise needed for full application is normally available only at major command headquarters and above. Again, to gain the needed insight into requirements, commands should use all five techniques and blend the inputs.

#### *specification*

Requirements as originally collected are not sufficiently detailed to permit programming, approval, or systems design. Fully specified requirements must answer the

familiar questions of who, what, when, where, why, and how many. Except for the why, discussed later, these details are called the parameters of the requirement. Specification is the process of quantifying the parameters, which in turn describe the requirement. A parameter is defined as "a variable or an arbitrary constant appearing in a mathematical expression, each value of which restricts or determines the specific form of the expression."<sup>5</sup>

Parameters give form to a requirement statement in the same manner that they do for a mathematical expression. To enable the designer to find the best solution, parameters must be expressed in terms of the requirement and not a possible solution. For example, required data rates should be specified in terms of what is actually needed, not in terms of commercially available bandwidths or equipment; the designer can then best determine how to provide the required data rate. Air Force Manual 100-17 lists such typical parameters as the requesting agency, terminal locations, traffic volume, security needs, required operational date, operational concept, related plans, and compatibility and interface considerations.<sup>6</sup>

Parameters are the criteria for system design. Later, when system design and trade-off decisions are made, it will be vitally important to know the basis for parametric values. If they were based on judgments, designers need to know the confidence level. Otherwise they might go to unnecessary expense or sacrifice of other capabilities in trade-offs to sustain one parameter at some arbitrary level. For example, in the design of digital command and control systems, it is essential, in order to provide sufficient transmission and switching capacity in the network, to know the allowed time to get a message from sender to receiver. Many other things such as traffic volumes, message lengths, and traffic distributions also affect capacity, but delivery times are sensi-

tive parameters, especially when specified to be within the range of a few seconds. Sensitivity implies that changes in the parameter's value cause significant changes in system cost. Very short delivery times associated with long messages equate to wide channel bandwidths, which cost much more than narrow-band channels. Because system costs can be sensitive to short delivery times, it is essential that such parameters be as accurate as possible and that the designer have some idea of how they were derived. Does one, for example, really need delivery within ten seconds instead of two minutes? If so, the designer can provide it, but at significant additional cost.

Parameters may also be operationally critical. Their values make a critical difference in a system's responsiveness. Some of the most operationally critical parameters are the delivery times required for messages that launch the SAC bomber fleets or warn the National Command Authority of an impending missile attack. Any delay in these messages can be equated with the possibility of having a portion of the strategic forces destroyed. For these vital messages, time is operationally critical. Delivery times down to five or ten seconds can be readily justified, even at greatly increased cost. In such cases, the systems analysis and systems engineering disciplines are indispensable for determining sensitivity or criticality and in assessing trade-off considerations.

Although not defined as a parameter, another important element of the requirement statement is the justification. Essential for establishing priorities or gaining approval and funding, justifications explain the requirement and the consequences of not meeting it. Needless to say, the justification and impact statements must be strong and vital in order to gain approval in today's funding environment. In this regard, one cannot overemphasize the importance of tying requirements closely to command mis-



sions. It is also critical, in the approval arena, that individual requirements be supportive and not compete with each other. This is one of the main values of having an integrated plan that encompasses all of a command's communications requirements; mission and interrequirement relationships can be examined and articulated.

#### *integration*

The development of a broad requirements plan is essentially the integration step. Integration itself involves a melding of requirements in such a way that planners can view the entire scope of a command's needs for communications services, identify overlaps or shortfalls, show how requirements relate to higher objectives, and spell out actions needed to remedy deficiencies.

The process of transforming requirements and their parameters into an integrated plan is more of an art than a science. The goal should be to portray a command's total requirements for communications—say over a five-year period—in sufficient detail to guide programming actions and assure that planners address problems as a whole. The plan need not include all parameters for each requirement; however, those details should be available elsewhere to furnish guidance to program managers and design teams. On the other hand, the plan must include such things as required operational dates, interface and commonality considerations, relative priorities, phase-out dates, general descriptions of the major requirements, and how they are to be satisfied.

Equally important is a narrative analysis of the key communications deficiencies and their impact on the command's mission.

This part of the plan should discuss relationships among requirements themselves and between communications requirements and the command's mission. If new data systems are programmed, the requirements plan should show how communications support will be provided. If on-line communications are required for several data systems, the plan should explore the possibility of providing a single, common supporting communications system. If that is infeasible, the plan should develop the rationale to support the acquisition of special-purpose communications for those systems that require them, both supporting commandwide programs and integrating communications capabilities.

A SYSTEMS approach toward communications requirements and the development of an integrated requirements plan are essential for laying a firm planning foundation. Communications requirements determine the missions of communications organizations. The interpretation of requirements and the way they are defined determine how well communications will be able to support the primary Air Force mission. This interpretation and definition, to be effective, must be applied on a broad requirements scale so that all deficiencies can be surfaced, interface and commonality considerations addressed, and requirements more effectively linked to each other and to higher mission considerations. The result will be a clearer understanding of communications objectives and better planning to achieve the primary mission.

*Headquarters Pacific Command*

#### Notes

1. John S. Foster, Jr., "Weapon Systems We May Face—and Better Have," *Supplement to the Air Force Policy Letter for Commanders*, United States Air Force, March 1973, p. 17.

2. Van Court Haze, Jr., *Systems Analysis: A Diagnostic Approach* (Harcourt, Brace & World, Inc., 1967), pp. 237-41.

3. Allan T. Demaree, "The Age of Anxiety at A.T.&T.," *Fortune*, May 1970 p. 264.

4. Foster, *op. cit.*

5. *American Heritage Dictionary*.

6. Air Force Manual 100-17, *C-E Facility and System Planning*, 12 June 1967, p. 9.



## FAST BURNER:

*Does He Hear a Different Drummer?*

LIEUTENANT COLONEL CHARLES W. ROADES

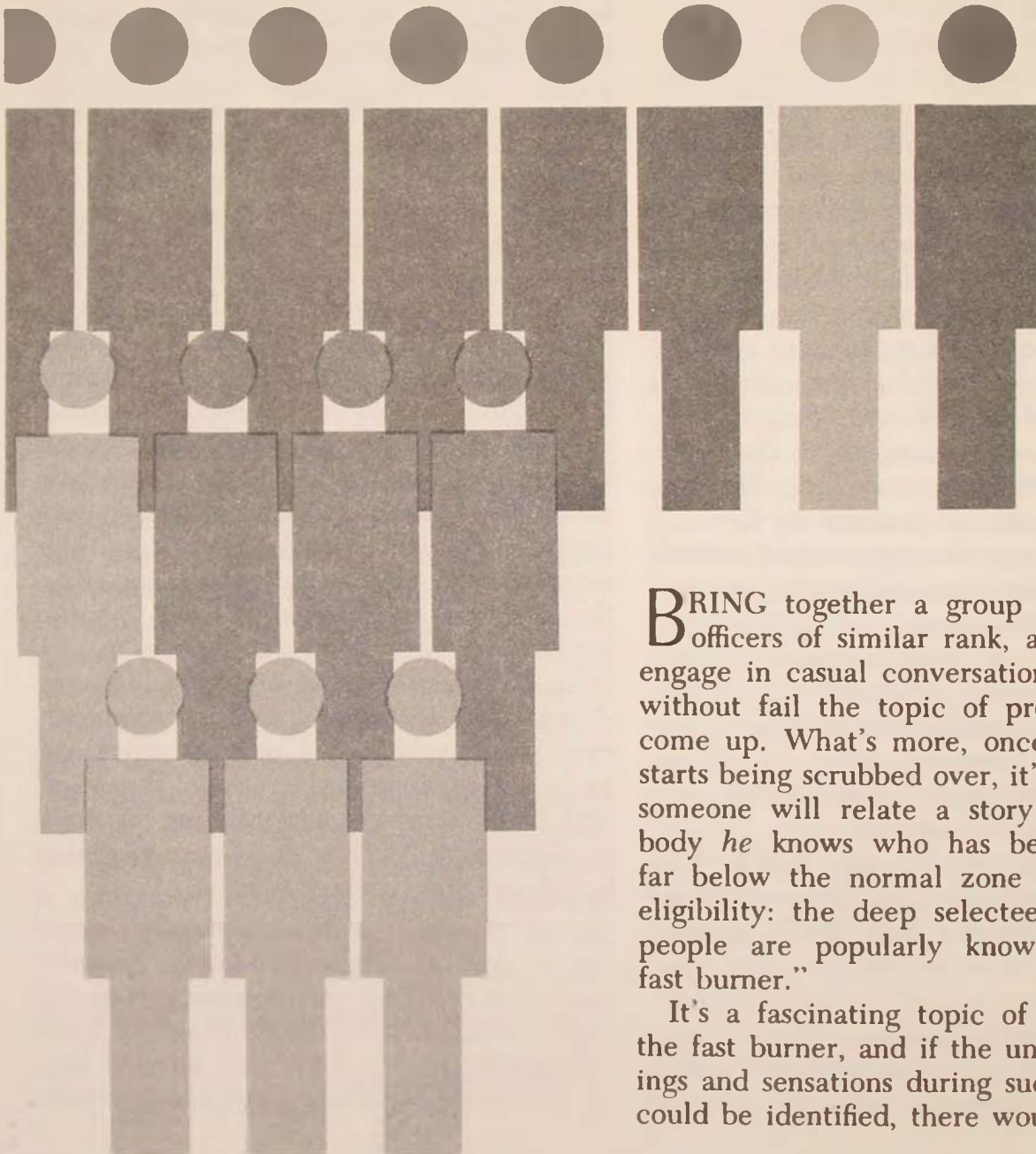

**B**RING together a group of Air Force officers of similar rank, allow them to engage in casual conversation, and almost without fail the topic of promotions will come up. What's more, once that subject starts being scrubbed over, it's a cinch that someone will relate a story about somebody *he* knows who has been promoted far below the normal zone of promotion eligibility: the deep selectee, or, as such people are popularly known now, "the fast burner."

It's a fascinating topic of conversation, the fast burner, and if the underlying feelings and sensations during such discussions could be identified, there would be among



them the sense of awe, a feeling of nonbelieving wonderment, a little reverence, a good deal of jealousy, some quiet tones of aspiration, regret, incredulity, etc., etc. The gamut from professional acceptance to nonacceptance could be found—and inevitably so. Our promotion system has spawned the fast burner, and certainly such a phenomenon is to be expected. What is expected, however, is not always understood. What characterizes the fast burner? How did he get to be one? What did he do differently to get where he is? What does he do now? What do I do with one if he works for me? And perhaps most important, what if I am one?

These are all questions that need to be objectively considered, to bring the reality of the fast burner into sharper focus, not just for the sake of passing interest but because the fast burner is a reality in the contemporary Air Force officer structure and will probably become even more so under the coming all-volunteer concept.

Accelerated promotion is the essence of the fast burner. Where the temporary promotion system has certain designated phase points for normal rank progression, the achievement of a temporary promotion before that established phase point represents a leap forward from the contemporary group. In effect, a man promoted ahead of his contemporaries acquires a new group of contemporaries, a group that entered the Air Force before he did, a group that is usually older both in age and in professional experience. This leap in contemporary groups can be as much as three years, and with more than one below-the-zone promotion an officer could conceivably be as much as seven years ahead of the year group with which he originally entered the Air Force by the time he reaches the grade of colonel. However, just as one swallow does not make a summer, one accelerated promotion does not

make a fast burner. On the other hand, if by sustained performance an officer should be selected a second time for early promotion, or a third, or even a fourth, then clearly a fast burner has been identified and recognized. By fast burner, then, and certainly without an officially sanctioned definition, is meant an officer who has been twice or more promoted from the secondary zone of eligibility. He represents an established record of demonstrated excellence along with the other factors that make up the opportunity spectrum to be considered early for promotion.

#### Fast Burner in the Making

How does it happen? What combination of talent and circumstance produces an individual extraordinary enough to leap ahead of his peers? Does he, as Thoreau suggests, march to the sound of a different drummer?

Central to the fast burner's success is his approach to and performance of his work. His whole ethic of work is one of the fullest possible understanding of what he is expected to do. Work is not an end, it is a means; it becomes a dynamic involvement that is studied, practiced, performed, and then assessed for the quality of its completion. The fast burner doesn't do his work to be done with it; he thrives on it, he gives it his central energies, and he keeps a constant awareness of how he could and will do it better the next time.

Some work seems painfully lacking in the sort of stimulation that could motivate an officer to perform at such a pace. But if that be the case, then the fast burner resorts to his own creative capabilities in an attempt to make the work more challenging. Even to the most routine of tasks, he can and will bring the refreshing relief of these thought processes because he *thinks* and thinks seriously about his work, and in

doing so he can see it in new perspectives. Not, however, without clearly understanding that new perspectives bring new responsibilities.

This application is all very appropriate, because such officers thrive on increased responsibility. Not in a self-centered sense of "See what I have to do now" but with the idea in mind that new responsibilities either bring with them ways to improve the work being done or perhaps lend themselves to unifying separate tasks that seemed otherwise unconnected. They provide new levels from which the work being done can be more easily seen in its total mission perspective. The fast burner seeks the "big picture," not because the shorter focus is less meaningful but because he is intent on seeing his worth in the entire working scheme of activities. What is more significant, however, is that after seeking the "big picture" the fast burner understands it when he sees it and can integrate his responsibilities into the making of such a grand view.

Does that make him superhuman? No, it simply means that, with the finely tuned abilities he possesses to do his job, the fast burner has a broadened focus not only on his known responsibilities but also on those which his excellence might create.

One very vital quality characteristic of the fast burner is his firm understanding of the leader-follower relationship. In consistently demonstrating his ability to work hard, long, and efficiently, he quickly grasps the most minute nuances of where his leadership lies and to whom he owes most firm allegiance. It is only natural that he do this, because, as stated before, he is able to integrate his own position and functions into the Air Force hierarchy. Furthermore, he is well aware that his achievements as a fast burner have been made because of the evaluations given to his work by his leaders. He knows whom he

works for, he appreciates the responsibilities that his superiors have, and his allegiance to them is firm. Because of these traits, he himself demonstrates the kind of leadership that is important at all levels of staff and command.

A frequent criticism of the fast burner from those who assess his achievements with something less than objective consideration is that he allies himself to the one man for whom he works to the exclusion of all others.

Not so.

This sort of criticism is simply trying to substitute the word "obsession" for "allegiance." Little if any work in the Air Force is done without collateral responsibilities to agencies, organizations, offices, etc., outside of the immediate chain of command. The fast burner, more perhaps than other officers, recognizes not just the need to work *for* his own superior but also the necessity to work *with* many others. It becomes a contradiction in terms to criticize the fast burner for narrow allegiance—the very talent that brings an officer to such status includes a broad sense of working responsibility. As a matter of fact, one of the traits that helps an officer achieve fast burner status is his awareness of the need for working harmony.

Finally, the fast burner has obviously needed one very important input in achieving his level of success: a consistent, careful assessment of his work, coupled with a clear understanding of his outstanding potential for more responsible jobs. While these may be the unanimous opinions of many who work with him, it falls the task of one individual to reflect this excellence on a rating form. But, more important, once that rating document has been submitted, that same individual, or one senior to him, must continue to monitor the progress of the fast burner's career. In other words, somewhere some one person must



be impressed enough by the excellence displayed that he becomes a sponsoring patron for the young officer. This is an absolute necessity for the simple reason that, in the competitive system making up the officer corps of the Air Force, individual excellence will never surface without the exposure provided by the directed interest of high officials in the hierarchy. Sponsorship is nothing new to the Air Force; it has been with us as long as there has been an Air Force. It is a necessary aspect in the sequence of events that surfaces the excellence of fast burners from within the vastness of the officer population.

The criticisms, myths, and fabrications about the sponsor system make fit material for a separate article, but the system does exist; more important, however, is the fact that it *must* exist and that it renders a vital service to the personnel structure of the Air Force. One of the most important functions of the senior military officer is to insure that capable, effective younger officers are recognized and promoted for their excellence.

#### Where Does He Go from Here?

The obvious answer to the question of where the fast burner goes from here is up. By definition, it should be evident to the officer that his accelerated promotions are not occurring by magic, nor are they something he knows little about. To have achieved one or more below-the-zone advancements has been a central part of the fast burner's aspirations, and any such success has naturally whetted his desire for more.

The fast burner will undoubtedly go to more broadening assignments, to more responsible positions, or to advanced levels of assignment within his particular general (not specific) area of expertise. For an officer with the proven effectiveness of a

fast burner, advancement represents the promise of broadened work demands and an intensification of his involvement within the general confines of his career field, with an eye toward achieving the highest possible rank and responsibility levels in the line of the Air Force. As he advances, this officer deals more and more with the abstractions of his career area and less and less with the specifics, since he has clearly established his excellence in them. He enters then into positions in which he assumes the responsibility for preparing, training, and evaluating the specific expertise of others.

Characteristically, the fast burner recognizes the limits to which he can advance in any one career area, and he begins early to widen his professional opportunity spectrum systematically through personal study, through educational courses, and by *carefully* (not frivolously) volunteering for those additional duties and responsibilities that will increase his experience but not divert it. A career conversation with a fast burner is inevitably a discussion with a man with a plan for himself. It is one he has carefully considered and structured, one that he constantly revises. He has projected for himself a realistic, achievable set of time-attainable goals, and he is on track to achieve them. He is a producer who clearly understands that naked, unchecked ambition must be tempered by firm achievements in whatever jobs he has to do. Further, he knows that courage is an important aspect of his plans: courage to set his goals and the foresight to know how to achieve them.

Probably the most welcome and refreshing characteristic of the fast burner in today's Air Force is his positive, assertive, "can do" attitude. This is not to say that he foolishly believes everything is possible; he is, after all, a realist. What he does believe firmly is that everything is worth trying, in

order to see if the way exists. The signposts of this attitude are obvious: first, he refuses to be caught responding negatively to requests to do anything. He won't make excuses or refusals to do things; rather he will question his requester and himself to find how he can do the job. And if he can't do it because of priorities or limitations, he'll do *whatever he can* to direct the work where it can be done. Second, he invariably infuses the same sort of working spirit into his people; his determination and theirs become one. Simply stated, the burner is a doer; and God knows, in an environment of dollar constraints and personnel cutbacks, he is more and more the man who makes the Air Force go.

These remarks are by way of a checklist of attributes of the fast burner. If you are one, then you can easily see yourself represented here. If you think you may be one, then check your own profile against these. If you are not one, then you are best advised to find an officer who is one and study his methods.

Having created the phenomenon of the fast burner, the Air Force has made it clear that such officers are needed in the system to make it function effectively. That need continues and will continue even more crucially in the future. Not only will Air Force senior officer departures and retirements be large over the next three years, but dollar cutbacks will demand that officer-leaders over the coming years get even more done with fewer resources than seems possible at the present.

Perhaps the real "proof of the pudding" of the fast burner system will lie in its ability to perpetuate itself along with the normally constituted promotion cycles. If those who have leaped ahead because of their unique abilities are genuine, then they clearly understand the need to look back to identify and sponsor the talented younger officers in the force. The

difficulties of the challenges of doing more with less are a perfect spawning ground for excellence in younger officers. The more testing the project, the greater will be the creative contribution of the young officer who is fast burner material. To keep it alive, he must be recognized and advanced in keeping with his demonstrated potential. And therein lies the greatest responsibility of the senior officer in assessing the work of the younger: Not only how much and how well has this officer performed, but what is his *potential* to do more and better in an ever rising function?

This naturally requires no small amount of objectivity to determine; but as was implied earlier, the sponsoring officer has to have an almost purely subjective gut feeling for the potential of a younger officer, and he must be willing to act on that feeling in recommending rapid promotion. The balance of the two is what creates and will keep creating fast burners.

### The System Works

No phenomenon such as this is wholly without problems, and here there are probably many. Three are worth mentioning.

First, it is patently obvious to anyone who studies the structure of the Air Force officer force that the promotion pyramid grows very narrow near the top. The laws, restrictions, and requirements governing the structuring of the general officer force make enlightening reading for anyone who feels that promotion probability is stable right up to the Chief of Staff. As a recent brigadier general promotee put it: "For every man who earns his first star, there are at least 250 individuals who are convinced he shouldn't have!" Perhaps overdramatic, but painfully accurate: about that proportion of colonels, one in 250, is promoted to brigadier general each year



Obviously a number of those 250 will be fast burners; and, all other qualifications being generally equal, how is the one man chosen? The point is that at the grade of colonel a plateau exists which is not easily passed en route to star rank, and if the fast burner who has arrived early at colonel watches a number of promotion boards go by without selecting him, he can suffer from some sobering and sometimes uncomfortable thoughts. He fully comprehends the structuring of the general officer grades, but his own personal, prolonged assessment of himself and his chances may cause him no small amount of agony.

Second, although the percentage number of below-the-zone promotions is strictly controlled, the desirability of being promoted ahead of cycle is very high, not only for the officer concerned but for the unit and major command in which he serves. It is wholly expected that the senior officers of one major command will scan a below-the-zone promotion list to see how many officers of other commands are there. Certainly the whole question of retention, motivation, replacement of key positions, etc., hinges on those numbers. What results, however, is an almost predictable inflation of OER's in ensuing rating periods, particularly those just preceding the next promotion boards. As a consequence, the entire shift is toward the 9-4 OER, and any aberration from those numbers can be, but will not always be, catastrophic for hopeful officers. When this happens, however, there follows (to the betterment of the service as a whole) a more careful and reflective scrutiny of the ratings being reviewed by both screening and promotion boards.

Finally, there is an unnecessarily false dilemma created by the fast burner phenomenon that works to the detriment of the officer and the system. A fast burner who receives two or more promotions below the zone comes to expect them because he has convinced himself that he has and is demonstrating great potential. If, at the first time he is eligible for the next rank in the secondary zone he is not selected, he tends to look on that as a passover and can suffer an immense blow to his perceived professional competence and self-confidence. Should he be eligible again below the zone and not selected again, he may be tremendously affected and understandably shocked. These sorts of things have happened—not with great regularity, but they have happened—and the affected officer may conceive of himself as on the verge of professional failure.

And there are still other problems, but not so great that they damage the intent of the fast burner system. It is, after all, a process that seeks the best, and as such it could not survive if it were only cosmetic in its intent. It is a system that affords the early rise of the most capable officers to positions of higher responsibility, and it represents the most credible judgment of senior Air Force leaders and managers about the potential of younger officers. Most important, though, the performance records of those who have become and are becoming fast burners demonstrate without question that the system works—for the good of the entire Air Force.

*Air War College*

# WHY MILITARY AIRPLANES COST SO MUCH AND WHAT CAN BE DONE ABOUT IT

MAJOR FREDERICK T. STARK

THE COST of growth of military hardware is increasingly the subject of national debate. Critics of the Department of Defense cite massive cost overruns on major weapons programs, usually aircraft, as evidence of mismanagement and waste. Regardless of why military weapons costs have gone up, the result is that we are faced with buying increasingly expensive weapons with a defense budget that is actually declining in relation to the gross national product and total federal budget.

It is important to understand how much military aircraft costs have risen when examining this subject. Obviously, one cannot compare the cost of a 50,000-pound F-111 to that of a 10,000-pound World War II fighter-bomber on any meaningful basis. The current airplane is larger and heavier, and for those reasons alone it should cost more. Also, the cost of factory labor during World War II was about one-fourth the cost of labor today. To get an accurate view of cost change, we should compare cost per pound in constant-value dollars based on factory labor pay rates. The cost per pound should be based on empty weight, since this is a truer reflection of the materials and labor that went into the airplane. Cost per pound is also a good measure of the price of other manufactured products, such as automobiles, civil aircraft, and appliances.<sup>1</sup>

Therefore, instead of comparing the \$60,000 cost of the World War II P-51 to the \$7,500,000 cost of the new F-15, we should compare them on the basis of cost per pound in constant-value dollars. The comparison then becomes approximately

\$36 per pound for the P-51 to about \$290 per pound for the F-15. Even these numbers are not precise, since there are other variables like production rate, amount of government-furnished equipment, labor productivity, extent of avionics, etc. Granted the imprecision of any set of cost numbers, the essential fact remains: aircraft cost growth is impressively large. We are currently paying eight times the cost per pound for fighter aircraft that we did in the 1940s. We are paying four or five times as much as we did in the 1950s and just under twice what we paid in the 1960s. These are production costs. Development costs have grown even more.

The cost growth has some important but subtle effects that can be likened to a circle. As costs increase, we can afford to develop fewer new airplanes. This means that those we now have must stay in the inventory longer. When we eventually do have to buy a new airplane, it represents a greater technological change. This change is made by design teams that have had less opportunity to gain experience in developing airplanes since fewer airplanes are being developed. The result is more development problems causing higher costs, and the circle continues.

Evidence that the circle effect exists can be seen in the reduced number of airplane types being developed (Figure 1), the increasing cost of airplanes (Figure 2), the increasing length of time aircraft remain operational (B-52, F-100, F-4, etc.), and the well-publicized technical problems in some of the airplane development programs in the recent past.



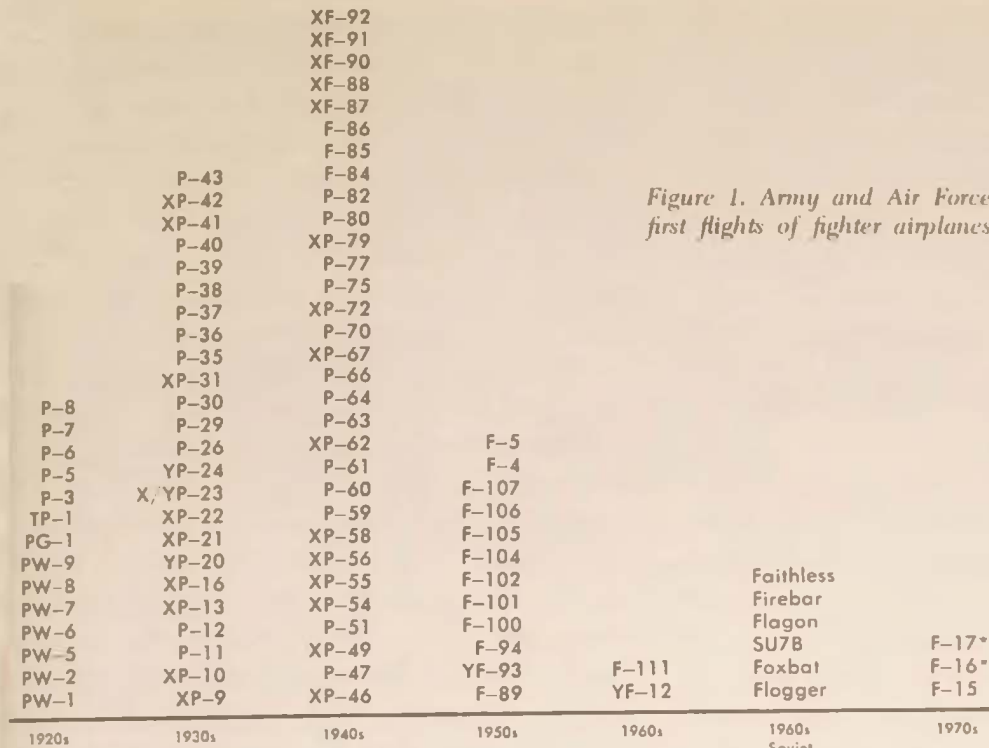

Figure 1. Army and Air Force first flights of fighter airplanes

Not shown: subtypes, such as P-51A, P-51B, etc.

\*Prototypes.

But costs for other things have increased in recent years, too, so perhaps military airplane cost growth is no greater than that of other products. Unfortunately, it is much greater. Automobiles have actually de-

clined in cost per pound in constant-value dollars. Commercial transport aircraft costs have increased only one-sixth as much as fighter aircraft, as indicated in Figure 2. Some consumer items, such as appliances

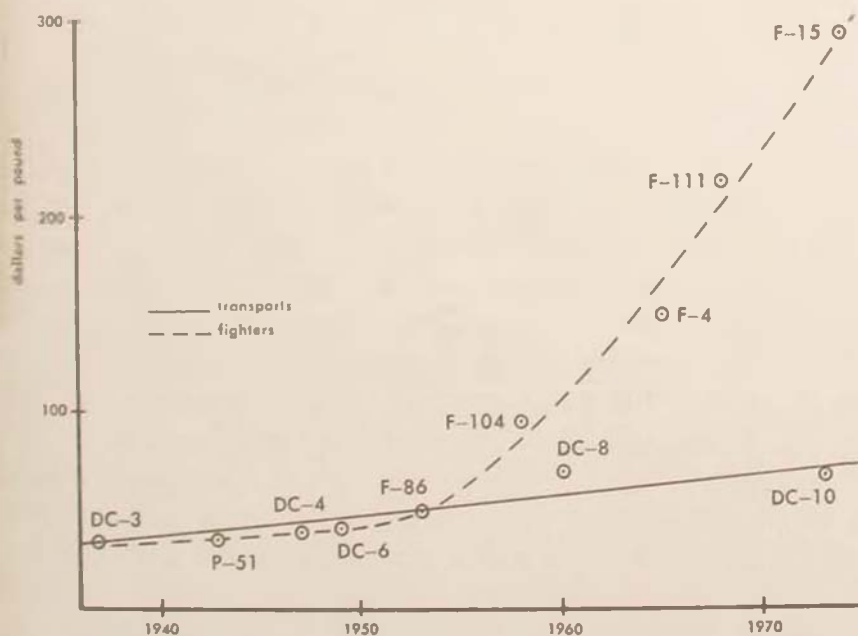

Figure 2. Cost per pound in 1973 dollars for transport and fighter aircraft

and electronic devices, have declined in unit cost in spite of inflation.

The cost growth of military airplanes is most often attributed to the advanced technology required to produce them. Although advanced technology is a major factor in cost growth, it tends to be used as an only excuse for increases in cost. Overall, technology has driven costs down instead of up. This is reflected in our increased personal buying power, which is keeping ahead of inflation. Nearly every product is superior to its equivalent of ten years ago and requires fewer man-hours of work to purchase because technological advances are applied both to the products themselves and to the means of developing and producing them. We have every right to expect that a new airplane developed today will be superior in nearly every way to one produced a few years ago. It will be made on better machines, made of better materials, have better facilities to test its components, and have a larger base of scientific knowledge available to its designers. These factors should tend to drive the costs down.

On the other hand we insist on additional capabilities or accessories that earlier airplanes did not have, and they obviously affect cost. But there is another, less obvious factor that has an even greater impact. We know from recent experience that we are going to have to keep a new airplane in the inventory for a long time, since new airplane programs are increasingly infrequent. In order to delay the point during its life when it becomes obsolete, there is a tendency to push the state of the art to its limits. It has been estimated by experts in the industry that, when pushing the state of the art, the last two to five percent of performance doubles the cost. Not only does the cost go up but reliability tends to deteriorate, which raises total ownership cost. And such developments are often made by design groups

that have little experience as a team because of the infrequency of development programs. This inexperience may lead to costly mistakes. Technology—or rather the application of technology too much toward end-item performance and not enough toward cost reduction—does have an important effect on cost increases. However, there are other important causes.

When a manufacturer plans for production, he normally establishes facilities, machines, and tooling to produce at a given rate at the lowest possible cost. Often the government plans for this optimum rate but buys at a different rate. It seems that to increase the rate beyond the optimum has little adverse effect on unit cost. This is because the fixed overhead does not increase in proportion to production rate, thus offsetting the increased costs of factory overtime or of adding more shifts.<sup>2</sup> However, when programs are in financial difficulty, production rates are often reduced in order to reduce the rate of spending. Invariably a sharp unit cost increase results, since fixed overhead continues over a longer period of time.

Changes in requirements normally have an adverse effect on costs, too. The seemingly simple addition of a cockpit instrument can cause a major rearrangement of the instrument panel, cooling ducts, electromagnetic interference protection, etc. Tests that were once completed may need to be rerun to verify the compatibility of the new device with other installed equipment. Many of the financial difficulties of recent programs can be traced to government-imposed changes. There seems to be little sympathy from Congress or the public for this kind of cost increase.

The way we procure aircraft has evolved into a very complex, institutionalized process. It takes more than 500 government people in several commands to buy a major weapon system; there are hundreds of



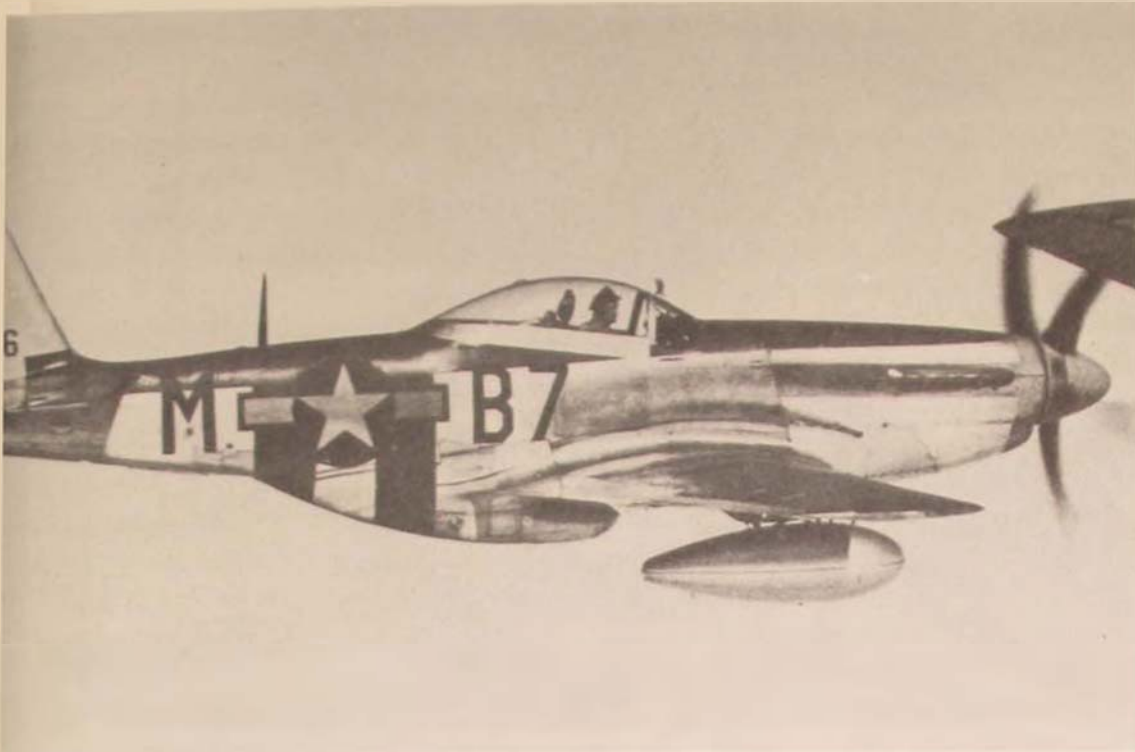

*The P-51 of World War II was developed initially for the British in 4 months from go-ahead to first flight. One of the most effective Allied fighters, it was also one of the least expensive at \$60,000, or \$36 per pound in today's dollars. . . . The F-15 is expected to meet its extremely high performance and schedule goals, but at \$7.5 million (not including R&D costs) it is expensive—\$290 per pound!*

Airplanes by the Pound





*The DC-4 of 1947 cost about \$450,000 or \$11.80 per pound in 1947 dollars, \$40 per pound in 1973 dollars. . . . The DC-10, developed with private capital, costs about \$18 million or \$69 per pound, including amortized development costs.*





specifications<sup>3</sup> that the contractor must comply with, and these people see to it that he does. They must know the status of the program every step of the way. They provide incremental approval for many of the contractor's actions. They impose management systems on the contractor, often more to improve their own visibility than to improve the efficiency of the contractor's operations. The result of this government involvement in the development process is that much of the contractor's effort is spent in satisfying government people. This takes the form of meetings, reports, briefings, movies, demonstrations, tests, etc. While some of this is necessary, most of it does not contribute to the success of the final product.<sup>4</sup>

It is an unfortunate characteristic of large bureaucracies that a great deal of effort is spent by some parts of the organization in answering investigations conducted by other parts. For example, the TFX hearings conducted by the Senate required thousands of Department of Defense man-hours to support. The threat of other such hearings, or of General Accounting Office or Inspector General investigations, causes protective reactions on the part of government agencies directly responsible for development and procurement of weapon systems. Protective measures ultimately result in documents, many of which are prepared by the contractor. Consequently, when an investigative agency inquires into why costs are going up, that agency is itself one of the causes.

In the last two or three years some important developments have been introduced to reverse the trends toward ever increasing costs by attacking their causes. The F-15 program is on schedule and meeting its cost objectives. Increased authority was given to the System Program Director, and streamlined lines of authority were established to eliminate at least par-

tially the need for "defensive" documentation. In addition, the competition for selecting the prime contractor stressed technical and management approaches above other considerations, insuring that the most capable contractor would be chosen. At the subsystem level there were important hardware competitions before selecting subcontractors. Lastly, the method of contracting provides the contractor with profit incentives for keeping costs down rather than rewarding him for cost increases, as often occurred under the old "cost plus fixed fee" contracts.

The F-15 in all probability will not suffer cost overruns that have characterized recent airplane programs such as the C-5, F-111, and F-14. This is a significant accomplishment. However, the F-15 is still going to be an expensive airplane. To attempt to reverse the trend to even higher costs, the Air Force has embraced the "prototyping" concept advocated by former Deputy Secretary of Defense David Packard. The A-X, lightweight fighter, and the STOL transport programs are being conducted under the prototyping concept. Actually, this concept is not new but a return to the time prior to the 1960s when airplanes rather than paper proposals competed for production contracts. In the case of the A-X, two prototypes competed in a fly-off. The winning A-10 was selected on the basis of actual performance comparison with the A-9. The A-10 has now entered into a full-scale development program aimed at production. The costs of the A-X development program will be under \$400 million, compared to the nearly one billion dollars it takes under conventional procedures to develop one airplane. The cost is substantially lower since the technical risks have been reduced by the fly-off. To date, prototyping is successful. The A-9 and A-10 in the A-X program have performed excellently, and the very low level

of funding has forced the contractors to consider costs as important as any hardware performance goal.

“Design to cost” is now evolving as a philosophy that is shaping programs of all the services. Simply stated, “Cost is a design goal just like reliability, weight or performance.” Where trade-offs are required, cost is one of the key considerations. For example, if a part can be made for one-half the cost at a weight increase of ten percent, serious consideration will be given to accepting the weight increase.

Hopefully, these are steps in a new direction toward lower-cost weapons, not merely a pause during the climb toward ever increasing costs. It is interesting that the government and weapons industry appear to be rediscovering what the civilian sector of our economy has known all along: i.e., competition and the resulting cost control are necessary for success. Perhaps we can further approach the characteristics of free enterprise in the civilian market and thus begin to approach the absolutely outstanding success it has had in providing more and better goods for less relative cost.

Some of the characteristics of civilian product developments are as follows:

a. With high technology products, the producer more than the customer determines what the customer wants and needs. Based on his perception of customer wants and needs, he develops his product.

b. Products are usually evolutionary in nature. They are ordinarily developed by a design team that is experienced with the product type and in working together as a team.

c. The producer recognizes that if his costs are not kept as low as possible he will lose sales and profit.

d. The producer is unencumbered by customer requirements in determining how he will design and build his product.

e. His “reward” for failing to meet the customer’s need is loss of sales, which, if continued, results in failure of the business.

The above are some characteristics of a free enterprise, free market system. No system yet devised has matched its performance. In recent years it has been widely accepted that military weapon systems cannot possibly be procured in a free market way. The most obvious reason is that there is a single customer, the government, and this customer is very unpredictable in his needs and desire to buy. In addition, the cost of development of a weapon system is prohibitive for private risk capital.

If the risk of dollar loss from developing weapon systems that are not purchased is removed, it is likely that many companies would welcome the chance to compete in a more or less free market atmosphere. It is possible to devise a way to do this and spend no more, and perhaps less, than we now spend.

In all likelihood there is going to be a continuing need for airplanes, ships, tanks, guns, and vehicles. These items, like most serially produced, manufactured items, benefit enormously from evolutionary development. Let’s take fighter airplanes as an example of how free market characteristics might be introduced into development and procurement. Suppose five aircraft companies were competitively selected and each was provided with \$50 million annually to develop prototype fighters. Each company would be required to provide the Air Force with two prototypes of a design for evaluation every two years. This is very generous funding in light of the YF-16 and YF-17 prototype programs, each of which has a prime contract cost of under \$50 million for two prototypes.<sup>5</sup> The determination of what makes a good fighter would be left primarily to the contractors. If they guessed wrong about Air Force needs, they would not get a production contract.



The prototypes would be in competition with each other and with aircraft already in the inventory. It would be the responsibility and desire of a contractor to prove that buying his airplane was more cost effective than keeping existing inventory aircraft or purchasing aircraft from his competitors. Failure to sell a new airplane would not result in financial disaster, and the unsuccessful design teams could remain intact, correct their weaknesses, and try to develop a more salable prototype.

The advantages to the Air Force would be substantial. At any one time there would be an inventory of prototypes of differing capabilities from which to choose. Should operational needs change, there would be a strong probability that one of the prototypes would come close to meeting the new need, since the contractor's perception of what the Air Force needs may be better than our own. (There are such examples in other high technology markets.) The contractors, if left relatively free from detailed specifications, would be more able to innovate. The successful innovations would be of great benefit to the Air Force while unsuccessful innovations would not cause cost and schedule problems experienced on recent programs.

But most important, we would develop a national resource, teams of designers with experience in developing actual flying military aircraft, as opposed to the current temporary teams characterized by massive

hiring and layoffs depending upon the winning or losing of contracts.

David Packard stated recently to industry representatives, "I am convinced, after spending three years in the Pentagon, that the [aerospace] industry is grossly overstaffed and very inefficient by any sound management standards." He went on to say, "I cannot in fairness place all the blame on the industry, for in many cases you have simply responded to what was asked for by some of the so-called 'experts' in the Pentagon."<sup>6</sup>

In the past couple of years some management innovations have been instituted in an attempt to slow or reverse the trend toward ever increasing costs. Hopefully, they will work, but they have a certain familiar "ring" to them reminiscent of cure-all systems of the recent past—concurrency, disengagement, Total Package Procurement, PERT. However, there is one important difference: competition of hardware. Only time will tell whether this is a step toward the efficiency of a more competitive, free market way of buying weapons or a timid hesitation in the march deeper into the bureaucratic mire that characterizes our present weapons acquisition process. If it is only a hesitation, the day may not be far off when Calvin Coolidge's question, "Why not just buy one airplane and let the aviators take turns?" will be applicable.

*McDonnell Douglas Corporation*

#### Notes

1. There are exceptions where extremely high quality or light weight is an important consideration. For example, a \$500 watch costs about fifty times as much per pound as a \$10 watch. Spacecraft, satellites, and ICBM payload cost is much greater per pound than that of aircraft due to the premium paid for light weight. However, for normal operational aircraft, cost per pound is a good measurement tool and is used by some manufacturers as a basis for pricing.

2. Fixed overhead in this context includes housekeeping costs, such as utilities, taxes, guards, and building maintenance plus the salaries of certain personnel who are necessary as long as the items are in production but whose work is not dependent on production rate.

3. The number of Military Specifications and Standards has grown to over 60,000. In some instances the specifications have become obsolete as a result of

rapid technological change; in others the specifications are excessively detailed. Sophisticated procedures are sometimes established to allow a contractor the freedom not to comply with obsolete or overly restrictive specification requirements.

4. A study by E. Gerloff, referred to in an article by Professor Albert Shapiro, "Complex Defense Systems Require Good Design Teams," *Defense Management Journal*, July 1972, indicates that there is little correlation between the success of a program and the specifications required by the government.

5. The total cost of each prototype program will be approximately \$100 million when government-furnished engines and equipment and one year of flight testing are added to the prime contract cost.

6. From an address by David Packard at an Aerospace Industry conference the week of 4 December 1972.

# ACQUISITION AND IDENTIFICATION OF GROUND TARGETS

MAJOR DAN ELIASON

THE ABILITY of tactical fighters to penetrate enemy defenses and to acquire, identify, and destroy ground targets has been a keystone of success in every United States aerial campaign from World War II until the present. To improve its air-to-ground strike capability, the U.S. Air Force has devoted considerable development effort and resources to the penetration of defense, accuracy of delivery, and lethality of munitions.

An equally vast area of research and development expenditures has been for aids to target identification under adverse visibility conditions, i.e., night and/or bad weather. Little attention has been focused on the problem of target acquisition under good visibility conditions.

My experience over a five-year period in the F-105, including 145 combat missions in Southeast Asia, has convinced me that simply finding the target during the daytime is our most acute problem. Discussions with people of greater and more varied experience confirm that rapid, certain target detection and identification are the dominant factors in the success of all air-to-ground attacks.

The Wright brothers began aerial flight observing the ground from very low altitude at a very slow speed and with a view almost completely unobstructed by the airframe. Over the years, visibility of the lower hemisphere has become almost completely obscured by aircraft structure, and enemy defenses have necessitated higher speeds and higher altitudes. As an example, from an F-4 in level flight at 20,000 feet, the pilot cannot see the ground for approximately five nautical miles on either side of

his flight path or approximately ten nautical miles ahead of his position. The viewing area for the crew member in the rear seat is even more restricted. To acquire and identify a target within the obscured area, the pilot must either fly an offset approach to the target or must change aircraft attitude by altering pitch and bank. The offset approach restricts flight path planning flexibility, and the maneuvering disrupts tactical formations, alerts the enemy, and increases exposure to his defenses. Higher altitudes not only widen the area of obscurity but also increase slant ranges. At slant ranges greater than 8000 feet (the nominal minimum weapon release range in a moderately defended area), it is difficult to acquire a truck target, even one in open terrain. Given ideal optical conditions of illumination and contrast, visual acuity is still a function of the angle that the target subtends at the aircrew's eye. Simply detecting a truck is only part of the problem. Once found, a truck must be observed in sufficient detail to ascertain if it is in commission, has been previously damaged, or is a decoy.

The employment of standoff weapons demands acquisition and identification of targets at even greater ranges. In environments of unsuppressed anti-aircraft defenses, optimal employment of standoff weapons necessitates standoff ranges in excess of 15,000 feet. Probability of detection for a target of opportunity from this range is extremely low. When operating against prebriefed targets whose locations and appearances are known and have been studied by the strike crew, the detection probability is only slightly enhanced.



Subtended visual angles and contrast of the complete target area may be sufficient to allow detection, identification, aircraft positioning, and weapons release beyond range of ground defenses. However, target acquisition and identification can still be impossible if the target scene is complex and accurate target designation requires isolating the target from surrounding background detail. Currently, the United States is spending a considerable sum on standoff and terminally guided weapons. Extreme accuracies are possible, but rapid, positive visual acquisition of targets at the required ranges severely limits full exploitation of these potentials.

In order to extend our visual acquisition capabilities, perhaps we need to borrow some concepts from Mother Nature. She has provided a solution to acuity limitations while at the same time retaining field-of-view. The hawk has coverage of almost the entire visual sphere with up to eight times the visual acuity of man. Hawks have other visual advantages over man: high sensitivity to motion of an object, extremely rapid accommodation, and a color-filter system to aid in identifying prey.

We need to borrow from this work of Nature. U.S. tactical fighters need a hawk-like system that provides an unrestricted view of the ground and high visual acuity.

Recent advances in the art of electrical-optical (E/O) devices have led to capabilities that could provide such a system. An E/O device is essentially a tv camera looking through a telescope. The target image is optically enhanced, received by a vidicon tube, converted to an electrical signal, routed to the cockpit, and displayed to the pilot in conventional tv format.

Although radar and infrared devices have their utility in detection, they do not provide the operator a sufficient bandwidth of information for long-range identification

of small targets. Given the premise that the majority of tactical strikes are conducted in conditions allowing the use of E/O devices, the emphasis on radar and infrared development appears out of proportion.

Electrical-optical devices permit scene magnification, longer stabilized viewing times, and enhanced contrast. Therefore, E/O techniques permit target acquisition and identification at ranges far exceeding those of the unaided human eye. These E/O devices can accomplish this while retaining image fidelity exceeding radar or infrared. These factors suggest the general desirability of an aircraft subsystem such as a trainable E/O telescope with a large off-boresight slewing capability. Such a video telescope system must have high magnification for good resolution of the explicit target area but must be coupled with a wide field-of-view optical device. The operator could use such a system in the same fashion as he uses his own eye. The low resolution, wide field-of-view (analogous to periphery of eye) would be for orientation, search, and initial acquisition of a point of interest. The high resolution, narrow field-of-view would then be pointed at these areas of the wide field-of-view that merit closer examination (analogous to the fovea of the eye).

This scheme would permit launch of extended-range E/O-guided weapons on targets that have been detected and identified by the pilot, using his video telescope device. If a laser receiver and/or a laser illuminator were also coupled to the gimbaled tracking telescope, the system would be usable for delivery of laser-guided munitions. It could be designed for cooperative missions, wherein the forward air controller provides the illumination or it is provided by the strike aircraft. Reflected laser spot detection capability would enhance its discrimination and also make it usable during night or adverse weather.

Incorporation of a large field-of-view, high-accuracy aid could provide the additional benefits of an excellent system to guide visually directed munitions or to point other sensors or designators precisely. From the defensive standpoint, the system would provide air-to-air identification at ranges sufficient to allow more optimum tactical offensive or defensive decisions and reactions.

Such a system would offer major new capabilities in the operations and intelligence fields. The video display for the aircrew can be preserved on video recording tape and played back immediately on a TV monitor after the aircrew is on the ground. This capability approaches near real-time reconnaissance for the tactical user by reducing the need for special photo reconnaissance missions, which require postflight image development or processing. Moreover, present data link technology will allow fighter aircraft video to be telemetered direct to ground monitor stations, thus providing true real-time, positively controlled reconnaissance capability.

Other advantages of the high-acuity viewing system include improved weapons release systems, improved sights, and on-the-spot battle damage assessment. The reduction in number of sorties resulting from these improvements, plus reduced attrition rate resulting from increased standoff capability, indicates the system would be highly cost effective. While initially oriented toward daylight/clear air mass conditions, visual acquisition at night or through partial obscurations must not be ignored. Present developments in E/O systems for visual capabilities under poor viewing conditions are promising and are an obvious follow-on. However, their development should not delay incorporating a basic daylight/good-visibility system. The E/O technology for such a system is here. Alternate versions of the required image

format and appropriate operator-to-sensor coupling schemes are under investigation but on a very small scale. The mechanical and aerodynamic considerations of sensor locations are quite straightforward, but they must receive early attention. Indeed, the requirement for a high-acuity, large field-of-view system must be emphasized and provided for during the conceptual phase of aircraft design.

In summary, a video telescopic device will greatly improve aircrew ability to acquire, identify, and destroy targets at much longer ranges. It will permit launch of E/O-guided weapons at increased standoff ranges. It can be readily adapted to the delivery of laser-guided munitions. Moreover, this capability will restrict the enemy's freedom of movement when U.S. aircraft are in the area. This capability can provide actual real-time E/O reconnaissance from high-performance tactical fighters during the entry, attack, and egress phase of strike operations.

The changing nature of tactical warfare demands improved target acquisition and identification to exploit greatly improved weapons in the face of harsh interceptor, surface-to-air missile, and anti-aircraft gun defenses. Improved standoff capabilities will lower combat attrition while increasing force effectiveness. In light of the continuing Soviet weapons and technological momentum, we must constantly strive to improve our tactical air power. Daytime, good-weather target acquisition, identification, and attack are our primary mode of tactical operation. We lack capability in this vital mission area. Great strides can be made quickly at relatively low cost and low risk by skillfully integrating current optical, electrical-optical, infrared, and laser technologies in our fighter aircraft. This needs to be done now!

*Wright-Patterson AFB, Ohio*



## Books and Ideas

# SWORDS INTO BALLPOINTS

*A New Outlet for Military Expression*

COLONEL HARLEY E. BARNHART



THE first issue of a new quarterly publication from the United States Strategic Institute was distributed to selected addressees in July 1973. † In an opening message, the directors of the Institute observe that "Armed Forces seniors, active and retired" have written little "on national strategic doctrine and the essential elements of a sound national security." Indeed, most of such writing "has been contributed

by academicians without military education, training or experience with conflict. . . . this can be a hazard to sound national defense . . . ." The Institute, therefore, will "encourage military professionals and others skilled in the military art to express their views . . . ." The USSI takes "no position other than to make available the pages of *Strategic Review*" for such papers.

To lead the way, five of the seven re-

† *Strategic Review*, a quarterly publication of United States Strategic Institute, Suite 1204, 1612 K Street, N.W., Washington, D.C. 20006 (tel. 202-393-1776); Vol. I, No. 1, Spring 1973.

tired military directors of the Institute have articles in this issue. These include General Bruce K. Holloway's advocacy of the urgent need to restore U.S. strategic superiority; an interview with Admiral John S. McCain, Jr., on the subject of our Pacific interests; and an extolment of our SLBM force by Vice Admiral Ruthven E. Libby.

To represent the active duty contributions that *Strategic Review* will seek, there is an article by General George S. Brown, outlining some of the realities of R&D lead times and contrasting our dwindling research effort with the burgeoning one of the U.S.S.R. The reader may sense that he has been here before as he encounters some of General Brown's evidence for the contrast, which cites increases in Soviet technological work force and education that are entirely disproportionate to our own concentration on social "sciences." Statistics comparing the numbers of engineering, mathematics, and physical sciences graduates being produced in the U.S. and U.S.S.R. were a commonplace of our post-Sputnik state of national alarm. The comparison has lost public interest in the glow of our successful space effort since then, in the state of national unconcern which accepts (and probably, in sum, approves of) the cancellation of the supersonic transport (SST) while the Tu-144 goes into production, and in the downward trend of our military R&D while the Soviets are profigate with new and experimental projects.

A look at the early post-Sputnik days is instructive. General Brown notes only a 50 percent gain in advanced physical science and engineering degrees in the U.S. between 1965 and 1970. By 1965, however, the effects of the post-Sputnik emphasis already had been observable. Between 1960 and 1970, advanced degrees in a group of "hard core" scientific disciplines<sup>1</sup> increased from 19,200 to 47,100—a 146 percent gain. Doctorates in engineering went from 786

to 3681; in mathematics, from 303 to 1236.<sup>2</sup>

Government encouragement of scientific-technical studies, a policy adopted as a result of our critical self-examination after October 1957, was a factor in these increases. More important than such directed measures, perhaps, in our free labor market, was the evidence to secondary and college students that scientific and technical careers were "where the action is" and would provide rewards commensurate with the effort they required.

Those who thought this way from the mid-60s on are emerging with their Ph.D. certificates to find NASA phasing down, military R&D in trouble with Congress, and experienced scientific-technical people from Seattle to Boston drawing unemployment payments. They are victims of the 6- to 10-year lead time between a career decision and a contributing role in R&D. The lesson will be noted by the more astute young people now entering college.

General Brown expresses concern over the momentum and concentration of the Russian R&D effort, which is fast eroding the technological superiority we have previously enjoyed. If our own military and space R&D continue in a downturn, the result could eventually be a cause for alarmed examination more traumatic than Sputnik.

Dr. Francis X. Kane, who has contributed several articles to the *Air University Review* dating from his active duty assignments with Air Force Systems Command, is represented in *Strategic Review* by a brief and trenchant piece, "Arms Control and Defense Spending." Kane argues that increased military spending will—or at least ought to—accompany the reaching of arms control agreements that attack the technological aspects of military competition in the absence of political reconciliation. We have, he observes,

... inverted the process. Instead of the logical flow from national interest to political



commitments to military forces to technology programs, we now deny that improved weapons are required by political differences and national interest. . . . If we restrain nuclear weapons in numbers are we more secure? The answer is no, unless we take proper safeguards against Soviet abrogation of the treaty or against their achieving technological surprise. . . . we need R&D to provide a base from which to produce new weapons in the event the treaties are abrogated; to learn where technology will drive security measures; to investigate how Soviet scientists might make breakthroughs; to explore where we will find new weapons to replace those eliminated or constrained by the arms control measures.

In the meantime, Kane notes, the concentration of arms control efforts on nuclear forces poses for us the problem of coping with the tremendous conventional forces of the Soviets—a staggering task at the prices that men and machines command today. (Consider our evident inability to produce a main battle tank at less than \$1 million per copy, driveaway price!)

Only a vastly comprehensive limitation and reduction agreement covering all approaches to firepower could restrain each side from pursuing qualitative improvements or making use of existing, nonproscribed forces to seize advantages. Does the atmosphere created by the “Spirit of Helsinki/Vienna” promise to lead to such an agreement, or to the mutual abnegation of capabilities which has been a hope of arms control advocates since the early sixties? Dr. Kane believes that it does not, although the pressures for the United States to forego qualitative improvements allowed under the agreement began with its announcement and continue unabated among critics of defense spending.<sup>3</sup>

The major part of *Strategic Review*, a special supplement comprising 142 of its 182 pages, is not encouraging to those who hope that the Soviets would reciprocate

unilateral gestures. It is an updated reprinting of John Erickson’s “Soviet Military Power,” originally published in 1971 by the Royal United Services Institute for Defence Studies, London.

Republication and widened distribution of the Erickson work are signal services, because there does not exist in the public print anything close to its fact-filled, informed, perceptive, balanced coverage of the subject.

One thing that emerges from Professor Erickson’s pages is the clear picture of Soviet leadership moving determinedly, after Khrushchev, in the whole spectrum of military capabilities, to erase areas of inferiority to the United States and to assure a margin at least of “sufficiency.” The Soviet doctrine of “sufficiency,” Erickson notes,

. . . involves having forces ‘sufficient’ (both offensive and defensive) to ensure an outcome favourable to the Soviet Union should war come—that is, if deterrence collapses—and maintaining sufficient strength in peacetime to have measurable edges of superiority measured in numerical terms. (p. xii)

Erickson finds the Soviet acceptance of the SALT-1 agreements consonant with this doctrine, noting continued and growing Soviet attention to conventional armaments and qualitative improvements in offensive and defensive systems not barred by the SALT-1 treaty and agreement. There is no evidence that scientists or engineers are being disemployed from military pursuits.

IN SUM, the pages of this first *Strategic Review* bear the common thread of alert to the need for adequate U.S. military strength in a perilous world. In the U.S. Strategic Institute’s statement of purpose and in its first editorial, there is promise that future issues will enlarge this scope

and serve as a forum for diverse viewpoints on foreign policy and national defense. Surely there is a place for an independent journal that will afford the responsible military commentator an outlet for expression, as a plethora of publications serve antimilitary critics. The expressed intent of the Institute to "take no position" is of course doomed to failure by the necessity to select manuscripts. Those "military professionals and others skilled in the military art" who wish to test the breadth of the

*Review's* interest have the invitation of the Institute to contribute.

The ussi is a nonprofit, tax-exempt institution. Initial financing has come from Mr. Arthur G. B. Metcalf, who is Chairman of the Institute and also Strategic Studies Editor.

The Institute invites inquiries regarding membership. (No "subscription price" for *Strategic Review* is announced.)

Maxwell Air Force Base, Alabama

#### Notes

1. Biological science, engineering, mathematics, physical sciences. A "soft core" group (English, journalism, arts, philosophy, psychology, religion, social sciences) went from 83,428 to 239,259 advanced degrees between 1960 and 1970—a gain of 187 percent.

2. Data from *Digest of Educational Statistics*, Office of Education, U.S.

Department of Health, Education, and Welfare, O.E. Bulletin 10024, Government Printing Office, 1962; and from *Statistical Abstract of the United States*, Department of Commerce, Government Printing Office, 1972.

3. See J. I. Coffey, "The Savor of SALT," *Bulletin of the Atomic Scientists*, May 1973, pp. 9-15.

## WRITTEN PELLMELL?

COLONEL DON CLELLAND

FOR a book bearing the distinguished authorship of Senator Claiborne Pell, the pun in this review title is probably no more pardonable than the book itself, but its claims are far less. It does not attempt to seduce with a portentous title like *Power*

and *Policy*. Nor is it jacketed with the hard-to-live-up-to promise that it will provide "a clear analysis of national self-interest."

*Power and Policy* is a small book, both in bulk and contribution.† Sixty-two of its 173

† Claiborne Pell, *Power and Policy* (New York: W. W. Norton & Company, 1972, \$5.95), 173 pages.



undocumented pages consist of a putative "model treaty" first submitted to the U.S. executive branch and later to the United Nations. The subject of this treaty is state activity in the exploration and exploitation of ocean space. Senator Pell just happens to be the Chairman of the Senate Subcommittee on Ocean Space.

In his acknowledgments, the Senator refers to "this little primer on foreign relations" and notes that "it has often been said that it is easy to make a simple thought a complicated one, but it is a very difficult job to make a complicated one simpler." Since by definition a "primer" is an elementary reading book, *Power and Policy* is not a primer, nor has it made things simpler. What it has done, in its attempts to do too much, is take a fascinating subject, weight it down with orthodox ideas and weary language, and toss it like cake from the balcony.

*Power and Policy* is particularly disappointing when one considers the author's credentials. As a college student Claiborne Pell traveled throughout eastern Europe; his father was the American minister to Hungary. And, in addition to his work as a member of the Foreign Relations Committee, Senator Pell has served in eastern Europe as a Foreign Service Officer and as the vice president of the International Rescue Committee to assist refugees of the 1956 Hungarian Revolution. Despite this, however, we find him in 1972 announcing, as though it were new: "We perceive not only that there are significant differences in ideology and practice among the Communist nations, but also that there has been a subtle yet marked mutation in the nature of the Communist system . . ." (Shades of Tito and Ho Chi Minh!)

Before commenting briefly on some of the positions taken by the Senator, I think it worthwhile to place side by side two direct quotations from *Power and Policy*:

Any study of diplomatic history, moreover, reconfirms the accuracy of Clausewitz's observation that war is merely the pursuit of policy by other means. (p. 23)

Clausewitz is no longer relevant. War can never again be merely "a pursuit of policy by other means." . . . (p. 99)

Those things said, what are the book's merits? Before proceeding to comment on them, I would like to emphasize that this country still seriously needs a brief, clear analysis of its role in foreign affairs. This cannot be provided, however, by a book that first posits that "all men have certain natural drives which, as we have seen in the political and economic spheres, include the desire for freedom, for human contact, and for property" and then ignores certain other *equally natural* drives in building its case. From Machiavelli to *Mein Kampf*, we have seen the evil side of man depicted too often to accept without question that which simply ignores the presence of these other drives.

The Senator's chapter headings sweep from "What Are the Lessons of History?" across "The Challenges" to "True Long-Term Objectives of American Foreign Policy." And as one reads, he becomes puzzled at the clichés—not only of language but of thought.

When the author says, "The gravest threat to our well being, however, comes not from outside . . . but from ourselves . . ." he seems to be on the track; then one recalls that he earlier said, "No Communist power can ignore the costs of Vietnam—proportionately far higher for the North Vietnamese than for us . . ." and wonders if the Senator sees the inconsistency in his statements.

Surely his calculations should not be restricted to dollars and cents. What about the inestimable damage done to the aver-

age citizen's dream of America, his thoughts about integrity up and down the governmental line, his pros and cons on the scars of wartime bombs and brutality, and the lingering national fester of amnesty? These things, and more, are the coin in which wartime "proportional" costs should be calculated.

It is frankly puzzling to lay down a copy of *Newsweek* that has featured an article on the severity of the world's energy crisis and then find Senator Pell saying blandly, "With the acquisition of atomic energy twenty-five years ago, man acquired all the energy he can use." (p. 100)

It is disappointing to read the sections in *Power and Policy* devoted to the recent growth of executive power at the expense of the legislature. Here one might expect a spirited attack. Instead, this accretion is explained away by blaming the technological revolution and its myriad details as insuperable obstacles to corporate decision-making.

At a time when other Senators are up in arms over the issue of executive privilege and reconstructing important lines of communication between the people and those who make policy, this Senator's solution to the problem of narrowing the growing gap between the Executive and Congress is:

I believe that as a matter of law we should adopt a requirement that the officers of the cabinet and other senior officers of the executive branch submit themselves to a formal question hour in the legislature on a periodic routine basis.

When our system of government is changing radically, and perhaps not for the better, one cannot help contrasting Senator Pell's approach with Dylan Thomas's challenge:

Do not go gentle into that good night,  
Rage, rage against the dying of the light.

*Robins Air Force Base, Georgia*

## The Contributors



GENERAL GEORGE J. EADE is Deputy Commander in Chief, United States European Command. During World War II he flew 37 missions in the ETO. He has spent much of his military career with the Strategic Air Command, as a B-29 pilot, Director of Operations, 7th Air Division, England; Commander of 2d Bombardment Wing and 7th Bombardment Wing; Chief, Single Integrated Operational Plans Division, Joint Strategic Target Planning

Staff. Prior to his present assignment General Eade was Deputy Chief of Staff, Plans and Operations, and Air Force Operations Deputy to the Joint Chiefs of Staff.



MAJOR RICHARD S. BATY (Ph.D., University of California, Los Angeles) is currently a student, Air Command and Staff College, following an assignment in electric propulsion at the AF Rocket Propulsion Laboratory. Previously Major Baty served in the Minuteman program at Malmstrom AFB, Montana, and in Space

and Missile Systems Organization (SAMSO), El Segundo, California. He has advanced degrees in aerospace engineering and control system engineering.



ALLEN L. JOHNSON (M.S.E.E., Northeastern University, M.B.A., Ohio State University) is a Group Leader, Air Force Avionics Laboratory, AFSC, responsible for flight-test evaluation of the airborne communication systems developed by AFAL. During the past 13 years at Wright-Patterson, he has been responsible for developing and testing several UHF and microwave air-to-air and air-to-satellite communication systems. He was previously employed



by the Bell Telephone Laboratories. He received the Scientific Achievement Award for the 1971 Ionospheric Scintillation Test.



BRIGADIER GENERAL NOEL F. PARRISH, USAF (Ret., Ph.D., Rice University), is assistant professor of history at Trinity University, San Antonio. Commissioned from flight training in 1932, he served as flying instructor and supervisor and as Commander, Tuskegee Army Flying School. Other assignments were as Special Assistant to the Vice Chief of Staff, Hq USAF, Air Deputy, NATO Defense College, and Deputy Director, Military Assistance Division, Europe. Assistant for Coordination, DCS/Plans and Programs, Hq USAF, and Director, Aerospace Studies Institute, Air University 1961-64.



MAJOR RALPH C. GAUER, U.S. Army, (M.A., University of Maryland) is an instructor in conflict theory and the Soviet political system at the U.S. Army Institute for Military Assistance, Fort Bragg, North Carolina. In April 1973 he was recipient of that institute's Distinguished Instructor Award. Prior military duties have included conventional and unconventional warfare assignments in Southeast Asia and intelligence assignments in Vietnam and with Headquarters, Department of the Army.



JAY MALLIN, A.B., Florida Southern College, is an author and journalist who specializes in military affairs. He worked in Cuba as a journalist, 1950-61, and since then has covered Cuban developments from Miami. He has traveled throughout Latin America and observed at first hand several aspects of Cuban subversion mentioned in this article. Mallin is

editor of the Series on Unconventional Warfare published by the University of Miami Press.



MAJOR CHARLES W. MITCHELL, USMA, Ph.D., University of Denver, was assigned to the Air Force Weapons Laboratory, Kirtland AFB, New Mexico, after graduation from Air Command and Staff College in 1973. He was Associate Professor of Electrical Engineering, U.S. Air Force Academy. Other assignments have been with USAFE and AFCS in Germany, AFSC at Eglin AFB, USAFSS in Japan, two AFIT tours, and two Air Force technical schools.



LIEUTENANT COLONEL JEROLD R. MACK is Aerospace Defense Command Liaison Officer to the AWACS System Project Office, Hanscom Field, Massachusetts. His assignments have been in Tactical Air Command, flying F-56s and F-100s, and with ADC as Weapons Controller in EC-121, manual and SAGE systems as Wing Stan/Eval pilot, EC-121, COLLEGE EYE Task Force Operations Officer, SEA, 1967-69, Hq ADC EC-121 Stan/Eval, and as Chief, Airborne System Branch, Command Control Division, DCS/Ops, Hq ADC.



CAPTAIN RICHARD M. WILLIAMS, after completing the Communications-Electronics Sys-

tems Staff Officer Course, was assigned to 823d Radar Squadron, Spokane International Airport. With the 552 AEW&C Wing, he has been Wing Communications Officer, COLLEGE EYE Task Force C&E Staff Officer, and Chief, C&E Division. He has served in Communications Systems Division, DCS/Ops, Hq ADC, and an ASTRA tour in Directorate of Command Control Communications, DCS/Programs and Resources, Hq USAF.



MAJOR CHRIS N. WILCOX, B.S.E.E., Purdue University; M.A., University of Nebraska) is assigned to Hq Pacific Command, Directorate of Communications-Data Processing (J-6), Systems Division. His last assignment was with Hq Strategic Air Command in the SAC Automated Total Information Network (SATIN IV) Project Office. Other assignments have been with the Air Force Technical Applications Center and Aerospace Defense Command in communications-electronics activities.



LIEUTENANT COLONEL CHARLES W. ROADES (USMA, M.A., University of Washington, M.S., Troy State University) is assigned to the Western Hemisphere Division, Office of the Joint Chiefs of Staff (J-5). He has been a transport pilot in the Military Airlift Command and served as assistant professor of English, U.S. Air Force Academy. He was Chief of Plans, 56th Special Operations Wing, Nakhon Phanom, Thailand, and Executive Officer, DCS/Plans, Hq Aerospace Defense Command. Colonel Roades is a 1973 graduate of Air War College.

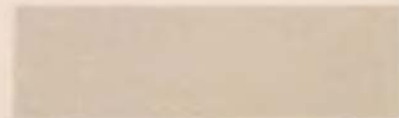



MAJOR FREDERICK T. STARK (M.S., Rensselaer Polytechnic Institute) is Chief of F-15 Engineering, Air Force Plant Representative Office, McDonnell Douglas Corporation, St. Louis. Most of his service has been in major weapon system R&D programs. He was in financial management and flight test in the Minuteman System Program Office (SPO) and has served as Flight Control System Project Manager and as a Configuration Control Board Chairman in the F-111 SPO. Major Stark was with the initial deployment of F-111s to Thailand in 1968.



MAJOR DAN ELIASON (M.S., University of Southern California) is a behavioral scientist

and project manager with the Aerospace Medical Research Laboratory, Wright-Patterson AFB, Ohio. His previous assignments include Flight Commander, 23d TFW, McConnell AFB, Kansas, and tactics officer, instructor pilot, and editor of the 388th TFW Tactics Newsletter, Takhli, Thailand. In addition to being an F-105 pilot, Major Eliason has served as an F-101B radar intercept officer.



COLONEL HARLEY E. BARNHART (M.A., Stanford University) is Assistant Editor, *Air University Review*. He was a fighter pilot in World War II, an Air Training Command instructor, and a B-52 commander. His staff assignments include duty with Deputy Directorate of Plans, Hq USAF; with J-5 and Military Assistance directorates of Hq USSOUTHCOM; and as DCS/Plans, Hq Seventh Air Force, Vietnam. He has been faculty adviser and Vice

Commandant of Air Command and Staff College and is a 1964 graduate of Air War College.

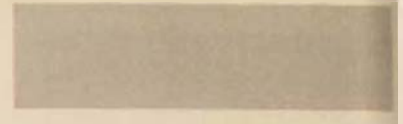

COLONEL DON CLELLAND (M.A., University of Colorado) is Chief of Plans, Hq Air Force Reserve, Robins AFB, Georgia. He flew a tour in RF-101s in Vietnam and was an F-86 pilot in postwar Korea. He has served in the Research and Analysis Division, Office of the Secretary of the Air Force; at the U.S. Air Force Academy as history instructor, Air Officer Commanding, and Special Assistant to the Superintendent, as Executive Assistant to the U.S. Representative, NATO Military Committee; and as Deputy in the Military Assistance Directorate, Hq USEUCOM.



The Air University Review Awards Committee has selected "The Threat, Foreign Policy, and Cost Control: Parameters for Force Planning" by Colonel Edward Stellini, USAF, as the outstanding article in the September-October 1973 issue of the *Review*.



## EDITORIAL STAFF

COLONEL ELDON W. DOWNS, USAF

*Editor*

COLONEL HARLEY E. BARNHART, USAF

*Assistant Editor*

JACK H. MOONEY

*Managing Editor*

MAJOR RICHARD B. COMYNS, USAF

*Associate Editor*

EDMUND O. BARKER

*Financial and Administrative Manager*

JOHN A. WESTCOTT, JR.

*Art Director and Production Manager*

ENRIQUE GASTON

*Associate Editor, Spanish Language Edition*

LIA MIDOSI MAY PATTERSON

*Associate Editor, Portuguese Language Edition*

WILLIAM J. DEPAOLA

*Art Editor and Illustrator*

## ADVISERS

COLONEL ARTHUR G. LYNN

*Hq Air Force Logistics Command*

DR. HAROLD M. HELFMAN

*Hq Air Force Systems Command*

COLONEL H. J. DALTON, JR.

*Hq Air Training Command*

FRANCIS W. JENNINGS

*SAF Office of Information*

COLONEL JOHN W. WALTON

*Hq Strategic Air Command*

COLONEL BOONE ROSE, JR.

*Hq Tactical Air Command*

## ATTENTION

*Air University Review* is published to stimulate professional thought concerning aerospace doctrines, strategy, tactics, and related techniques. Its contents reflect the opinions of its authors or the investigations and conclusions of its editors and are not to be construed as carrying any official sanction of the Department of the Air Force or of Air University. Informed contributions are welcomed.



UNITED  
STATES  
AIR FORCE  
AIR UNIVERSITY  
**REVIEW**